

Switches Sockets and Accessories Product Information and Price List



Company Overview

A Professional of electrical switchgear, Norisys constructs innovative switchgear systems and has established itself by many years of experience and high quality workmanship. Norisys is committed to being recognised as a premier destination for electrical products.

Each day Norisys engineers work to bring about a combination of innovative designs and materials using advanced manufacturing technology in order to create products that are best suited to meet user requirements.

We continuously strive to upgrade processes and materials. CUBE Series and SQUARE Series products thus ensure sound electrical performance.

Products such as Modular MCBs, Single Phase Motor Starters, Power Units for airconditioners are all products made by Norisys, and have today become common household products. Quality is ensured at every stage.

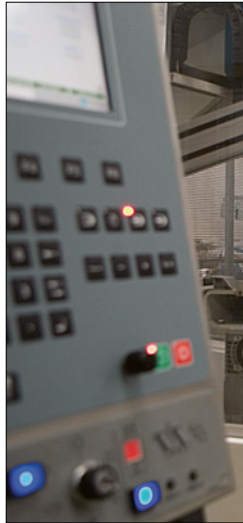

The manufacturing plant is equipped with modern state-of-the-art machinery and equipment. In-house facilities for testing and quality assurance of all components ensure guaranteed quality. Extensive material selection process and rigorous quality monitoring process is followed for conformity to highest standards.

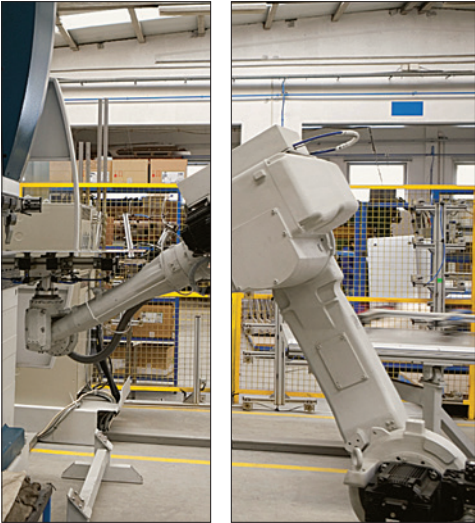

All products from Norisys have been developed to establish new standards in electrical accessories. Commitment to superior designs, elaborate attention to engineering details, modern manufacturing facilities and stringent quality measures have combined together to create a new concept in safety, reliability, flexibility and modernity.

Norisys has a full fledged, well equipped research and development division which works constantly to improve, innovate and engineer new products. This research and development division has a fully integrated product development environment that directs the development process throughout - right from conceptual design to manufacturing.

All Norisys products are designed for extreme endurance. Materials are chosen to withstand arduous conditions. Local wiring practices are carefully studied before designing any new product at Norisys. This ensures ease of installation and durability of the products.

Bi-material Frames engineered for toughness

CUBE Series products are designed for tough performance. The products are mounted in a way that the entire pressure of wires in the junction box is borne entirely by a sturdy bi-material frame.

by this mechanism and it maintains uniform gaps between the modules. This mechanism uses locks which remain free from any stress after mounting, thus making the system extremely durable with long life.

4

The bi-material support frames in CUBE Series is the result of several man-hours of research and development. The bi-material frames are made of a combination of steel and engineering grade plastic. In this design, the steel structure is embeded into plastic. The steel inside gives the bi-material frame a rigid structure while the plastic provides the anti-rust and insulation properties.

Wiring connections can be made upon fixing the modules on the bi-material frames. Cover plates can be mounted after final painting of walls, thus preventing the plates from getting soiled during construction and painting work.

Modules are mounted on the bi-material frames using a unique snap-fit mechanism. This snap-fit mechanism is highly accurate thereby ensuring that all modules fit comfortably without the need of force. Location of the modules on the bi--material frames is controlled

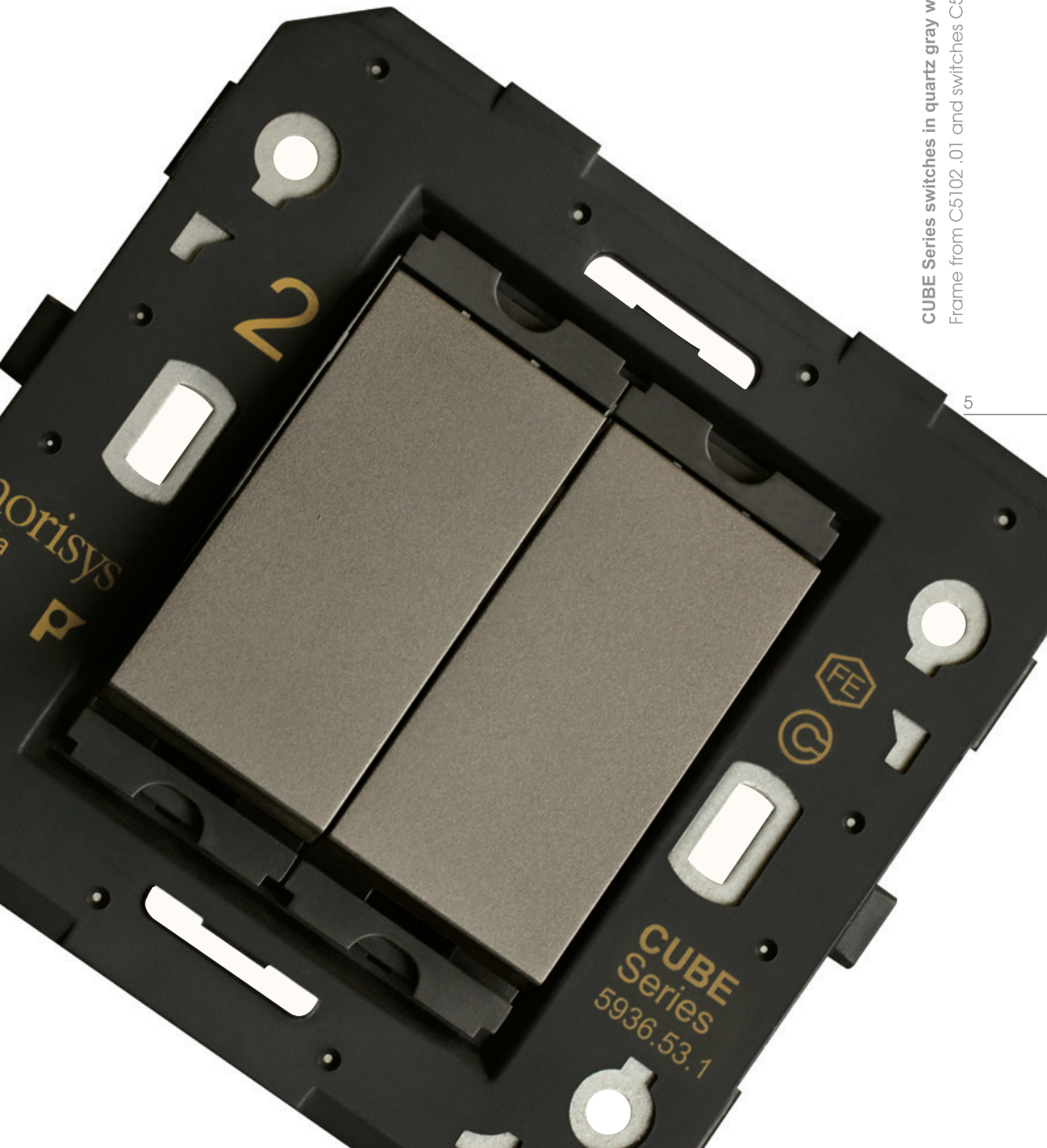

CUBE Series switches in quartz gray with a two module frame
Frame from C5102.01 and switches C5110.02

CUBE Series

CUBE Series is a modular product range which is designed to satisfy the requirements of electrical installations in modern buildings.

The range includes switches, sockets, fan regulators & dimmers, hospitality products, communication sockets, acoustic and optical signaling products, cover plates etc.

Modules such as switches, sockets etc. are made to a standard size (module) which are mounted on frames. Front plates are available in a variety of colours, materials and finish. The front plates can be changed at any time without disturbing the wiring to adapt to changes in building interiors.

Use of engineering grade thermoset materials in CUBE Series products makes the range extremely strong and sturdy with flame proof qualities. The engineering grade thermoset material used in the products has

excellent electrical insulation properties and does not catch fire. This ensures that the products are capable of handling higher operating temperatures. This engineering grade thermoset material is conventionally used in industrial applications where high degree of electrical insulation is required.

CUBE Series quartz gray switches & sockets with solid wood plate
Switches C5110, 02 Socket C5212, 02 and Plate CW304, 06

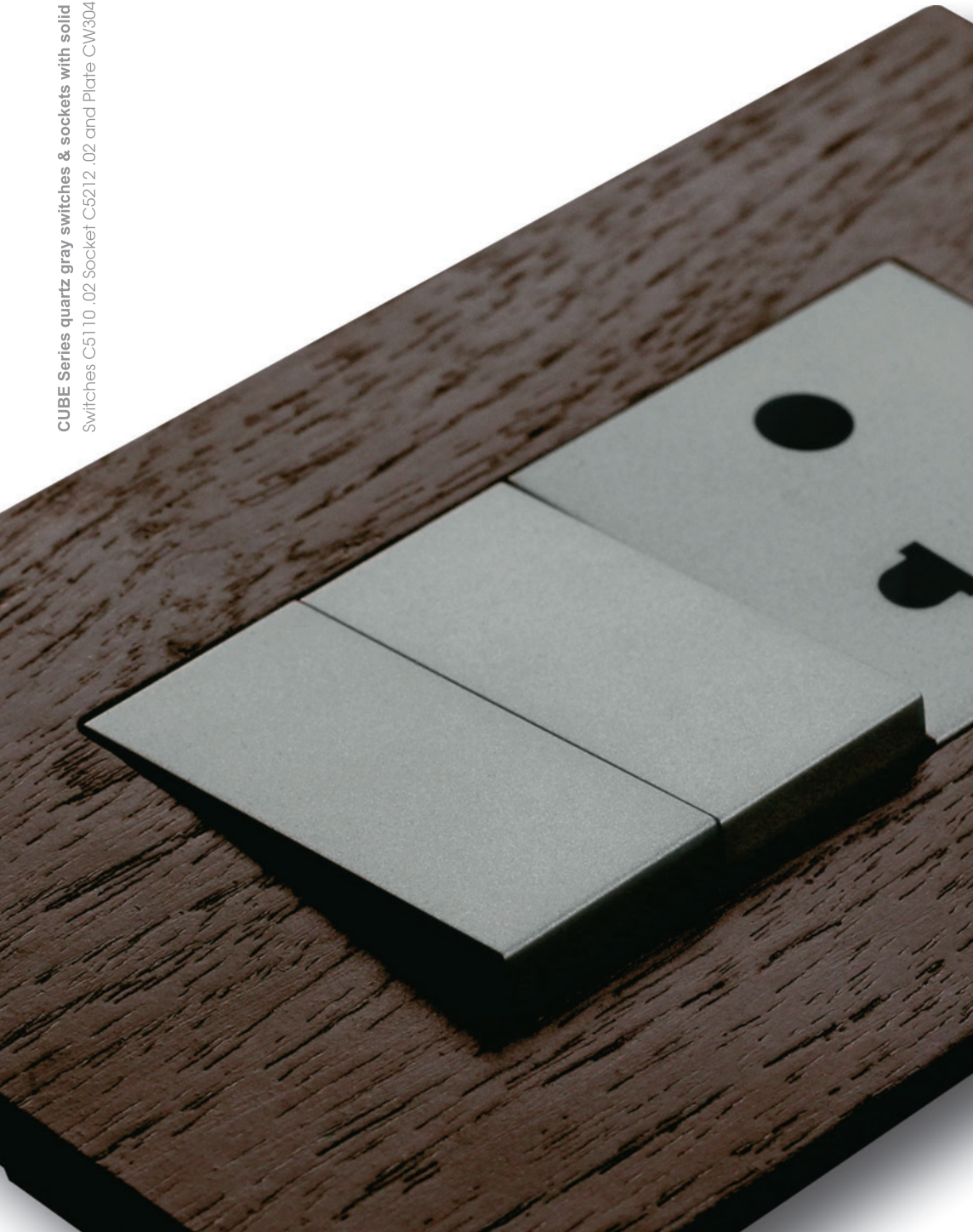

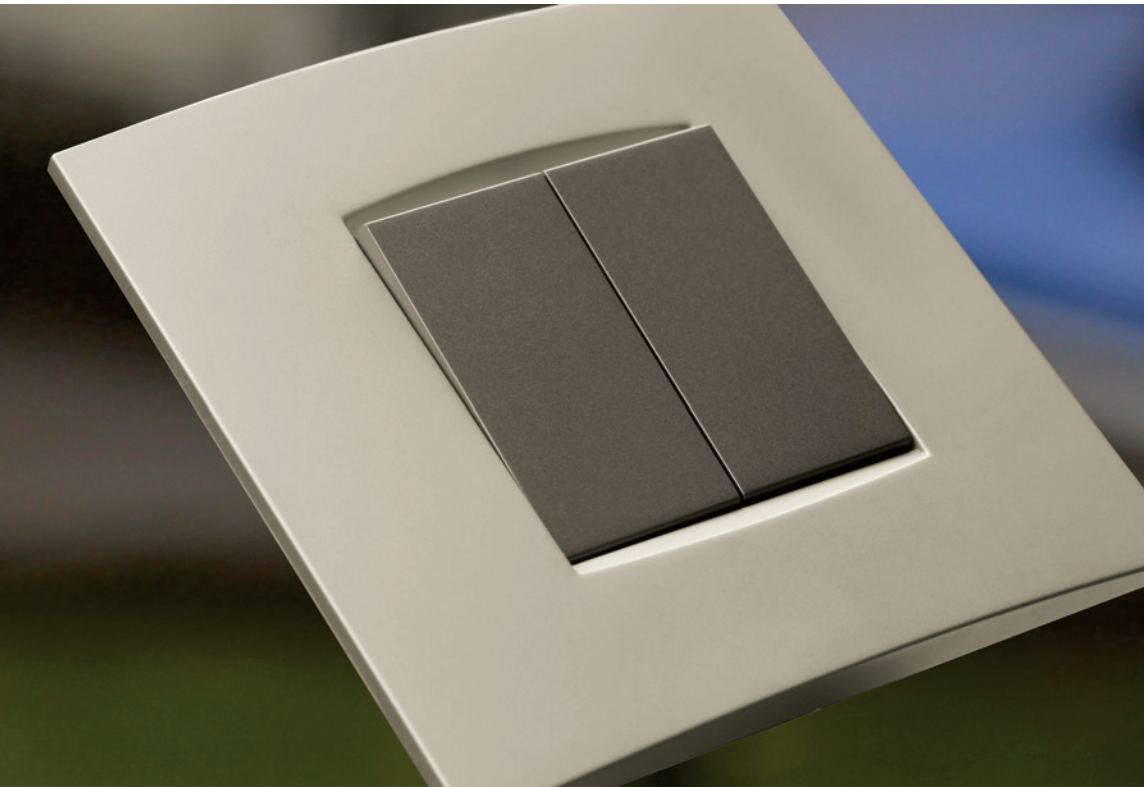

Norisys engineers have been working day after day with diligence in order to ensure consistent electrical, mechanical and thermal qualities.

CUBE Series

the technology inside

CUBE Series switches have contacts which provide very high current carrying capacity. The contact design, snap action mechanism, appropriate contact pressure, wiping action between the contacts and use of high engineering grade materials result in minimum arcing. Reduction in arcing ensures a very long operating life for the switches.

Proper shrouding of terminals and current carrying parts is provided in all switches and sockets. Since the live parts are separated by thermoset material, they are prevented from fusing together in case of any over-heating.

LED indicators used in the CUBE Series switches emit a soft, reassuring glow which is mild and soothing to the eyes. Use of high quality LEDs ensures a long indicator life without flicker.

Norisys engineers developed a unique ring-shaped spring which solves the frequently occurring problem of burnouts in power sockets. Norisys sockets feature this ring-shaped spring which maintains a uniform pressure on the brass contact tubes. This pressure clamps the plug pins tightly leading to a firm spark-free contact, thus eliminating overheating and consequential burnouts.

CUBE Series sockets are child protected. Safety shutters have been put in place to prevent any accidental contact with live parts thereby reducing risk of electric shocks.

CUBE Series

tiny mcb - modular mcb system

Tiny MCB is a high performance and a reliable safety device, which has now become a common household product. It is a modular MCB that can be mounted simply like a switch. These MCBs are front mounted alongwith switches, sockets etc. of CUBE Series or SQUARE Series products. Tiny MCB can also be mounted on sunmica sheets of any existing or new receptacle commonly used in household wiring.

Single Pole and Double Pole versions are available in Tiny MCB in various ratings. Distribution Boards for single phase are made using Tiny MCBs on CUBE Series or SQUARE Series plates or even on sunmica sheets. These distribution boards are compact and smart. When mounted with a 25Ampere socket, it offers the perfect solution for switching airconditioners and geysers.

Tiny MCBs are high performance devices that incorporate advanced developments in electrical engineering technology for protection of circuits and individual appliances. They are typically used for switching and protection of air-conditioners, geysers, pumps, heaters and other appliances that draw high current in domestic applications. These MCBs are also used as a master switch in rooms to switch off the entire circuit in a room for energy saving.



Solid Aluminum Black Finish Plate with quartz gray switches
Plate CA304 .05 Switches C5110 .02 Bell C5310 .02

CUBE Series

fan regulators & vector plates

Fan regulator in CUBE Series demonstrates the way engineers at Norisys pay attention to product details. The knob featured in this device solves the common problem of knobs coming off or falling. The dual knob design ensures that the knob cannot be pulled out, thus ensuring that the knobs remain intact even after years of usage.

The unique bar shaped knob is a visual treat and blends with modern interiors, besides being ergonomic. The bar shaped knob is easy to grip and is much more comfortable to operate than regular circular ones.

This fan regulator is a totally dependable device that eliminates failures normally experienced with electronic regulators. It has full rotation operation with no end point, thereby preventing any undue pressure from damaging the regulator. Total hum-free operation, six speeds of operation,

no radio interference and negligible power loss are other benefits of this regulator.

CUBE Series Vector Plates incorporate a redefined design capable of harmoniously blending into different living styles. These plates are available in Frost White, Quartz Grey and Ice Silver colour options. The shape of these plates is urbane and exudes aesthetic elegance. These plates are made from high gloss virgin grade UV stabilized engineering plastics.



Vector Plate in Ice Silver colour with two switches & fan regulator

Plate C5404 .03 Switches C5110 .01 Fan Regulator C5900 .01

Each piece of Solid Aluminum plate is machined out of a solid block of aluminum to give it the sharp and clean look. These plates are available in natural finish and black finish and match very well with Frost White modules and Quartz Gray modules. The complete look is a solid, well engineered smart composition.



CUBE Series

special material machined plates

Norisys special material plates set the standards for stylish design combined with top quality materials: Solid Aluminum, Solid Glass, Solid Wood, Solid Marble finish. The classy design creates an exclusive flair owing to the interaction of contrasts between the severity of optical forms and surface finish.

Solid glass plates are made of engineered glass which is tempered and toughened to make it rugged and to impart a nice uniform lustre. Solid glass plates are available in Ice White and Metal Gray colours. Both the options provide a radiance to the interiors.

Solid Wood plates are crafted out of best quality natural wood, which is treated and seasoned to ensure a long life. These plates are offered in Natural Pinewood Polish and Dark Mahogany Polish. Special Protective coatings and surface hardeners make the surface wear

resistant. Wood lends a natural feel to the clean edges of engineering plastics and metals. This natural feel can be an asset for interior designers for making the electrical outlets blend with the furniture.

Solid Marble finish plates are individually machined from solid blocks so that the end product is a crisp clean cut flat plate which looks modern in aesthetics. The Sparkle White option matches very well with white marble whereas the Terra Beige option matches very well with marbles from the Beige and Brown family. Once mounted alongwith the CUBE Series modules, it merges the looks of technical accuracy with natural marble feel.

CUBE Series

CUBE Series marks the evolution of Norisys' research as it once again focuses on engineering design, especially its environmental qualities, and pivots on the concepts of variability and sustainability, performance and simplicity of use.

16

It is a new way of creating environments, made possible by the types of products that have been developed, namely by using advanced materials and engineering. The result is an installation system that seamlessly blends with the building.

As a professional of electrical switchgear, today Norisys constructs innovative switchgear systems at the highest level and has established itself by sheer experience and high quality workmanship. The two product ranges namely CUBE Series and SQUARE Series, make sure that products are available for highly specific requirements as well.

In CUBE Series switches, the spring geometry of the moving contact of the mechanism has a natural cushioning function, which significantly reduces its electrical recoil as well as wear. An increase in the quantum of silver in the contacts, helps to reconcile the safety of electric switching with smoothness of operation.



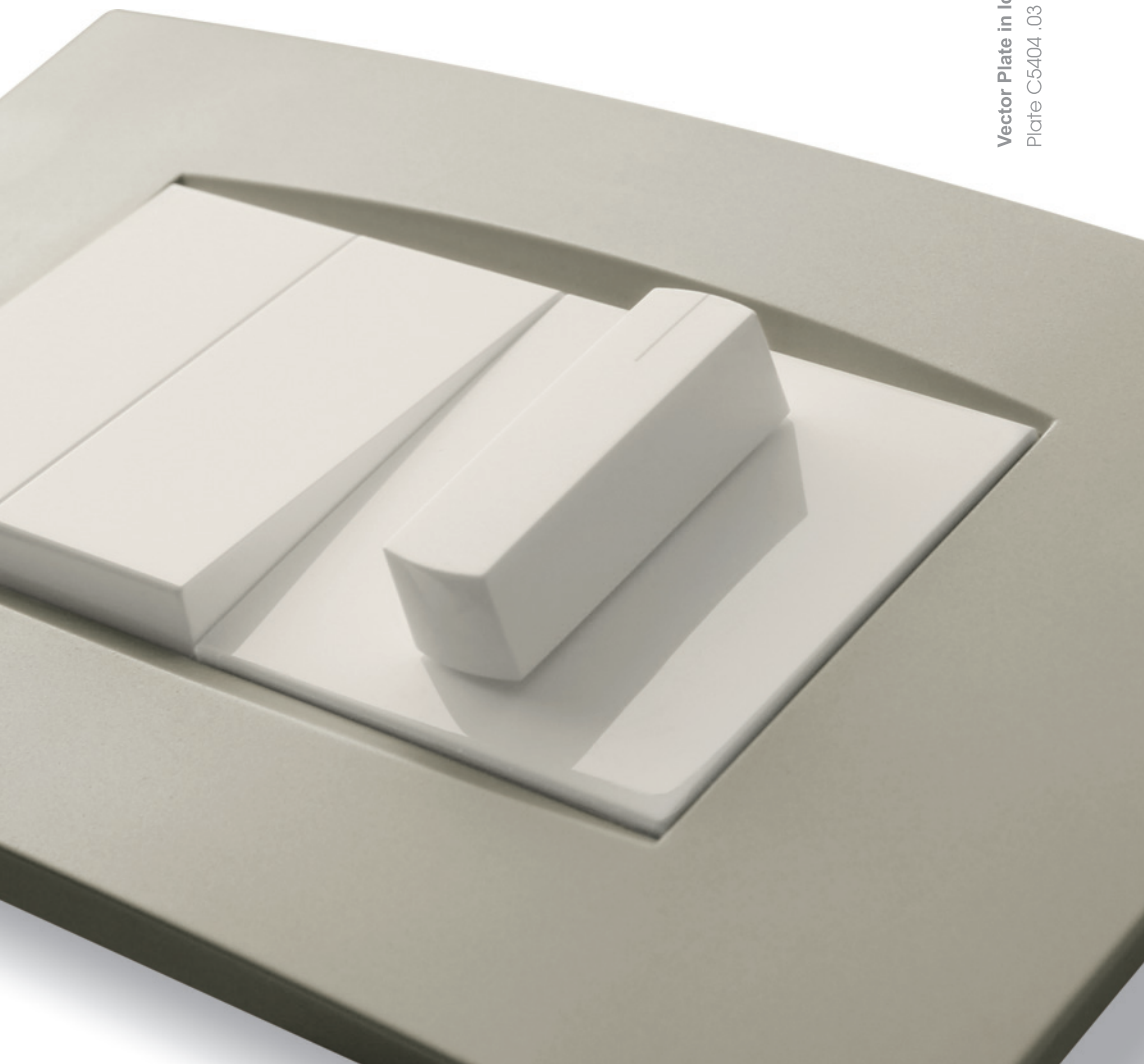

Vector Plate in Ice Silver colour with two switches & fan regulator
Plate C5404 .03 Switches C5110 .01 Fan Regulator C5900 .01

Architecture of modern hotels and hospitals makes the highest demand for design and function of electrical installations. Norisy offers high-end products suited for the hospitality industry.



CUBE Series

hotel installation systems

CUBE Series installations do not only look good, they are also ideally convenient to operate. Especially for use in hotels and hospitals where one seeks quiet and wellbeing. It is important to have fittings that stand for good feeling.

Products like Shaver Sockets, Key Card Switches, Call bell system with register, Buzzers, Speakers for Music circuits, Step Marker Night Light, Do Not Disturb and Clean My Room dedicated switches, Bell Switch with DND & Clean My Room connections provide the necessary convenience for guests in hotels.

Smart Plates in CUBE Series have a distinct classic design offering comfort to the eye. The plates merge with the interiors very well creating a homogeneous look. Inner bi-material frames give adequate support to the plates keeping all the modules securely in place without yielding to pressure from the wires inside or during insertion / removal of plug tops.

Good quality data sockets are a prerequisite at all workplaces because of increasing speeds in data transmission. Norisys communication sockets are available for all types of telephone and data connections. Shutters for dust protection is provided in all data sockets along with a circuit marking label with a clear cover. The marking can give clear indication on the data line connected to the socket. Communication sockets are available for Cat 5, Cat 6, RJ-11 lines.

CUBE Series

single phase motor starters

Single Phase Motor Starters - a safety device designed by Norisys engineers with advanced current handling. It is a device for switching and protection of appliances such as room air-conditioners, refrigerators, washing machines, computers, water coolers, pumps etc. up to 25Amperes. In case of overload, the Single Phase Motor Starter trips, thereby protecting the appliance from burn-out.

These starters are normally mounted with sockets from CUBE Series or SQUARE Series. This combination forms an efficient module for single phase applications. The unit is compact and economical and is operated by the push of buttons located in the front of the Starter.

Installation of Single Phase Motor Starters is very simple as they can be installed simply like a switch. They can also be mounted on Surface Mount Boxes from Norisys for an elegant stylized look.

The unique feature of Single Phase Motor Starters is the facility of current setting. The starter tripping can be precisely set as per the requirement of the individual appliance. This setting can be done simply by the turn of a screw provided on the front panel of the starter. After setting the starter tripping current, the device protects the appliance from overloads with desired precision.

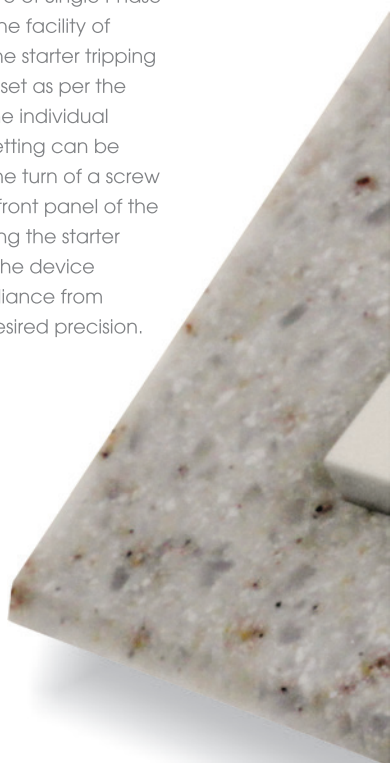



Solid Marble Finish Plate Terra Beige with switches in Frost White
Plate CM304.11 Switches C5110.01 & Fan Regulator C5900.01

SQUARE Series

SQUARE Series products is a design which has evolved over a period of time. Functional qualities and the mounting system is proven and the technology tested. Classic looks of this range makes it a timeless design.

22

Unique feature of this Series is the mounting system. All modules are mounted on frames using screws. This makes the assembly very sturdy. The modules which are mounted by screws can withstand tremendous amount of pressure. Back housing of sockets rest on the frame and provides a firm support - required in case of excessive push pressure while inserting plugs.

SQUARE Series products retain the special features offered by the company in the past, yet have been redesigned for modernity. Use of thermoset material for the core areas makes the switches and sockets highly durable and capable of handling higher currents.

UV stabilized virgin grade polycarbonate material is used in SQUARE Series to impart a highly polished glossy surface. Locators in the modules and frames facilitate accuracy in mounting ensuring uniform gaps between the modules. Spring loaded tubes in sockets ensure a firm contact with plug pins for smooth operation.





SQUARE Series switches in frost white with a two module frame
Frame from S7602 .01 and switches S7110 .01



C5110 .01
C5130 .01
C5730 .01



C5210 .01
C5230 .01



C5310 .01



C5441 .01

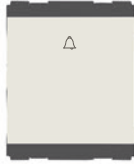

C5340 .01

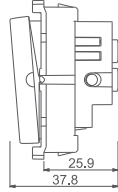

C5111 .01
C5131 .01
C5731 .01



C5211 .01
C5231 .01



C5311 .01



C5431 .01

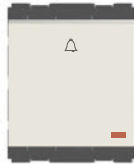

C5341 .01

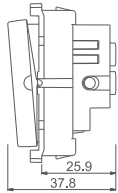

C5140 .01
C5160 .01



C5180 .01



C5240 .01
C5260 .01



C5280 .01

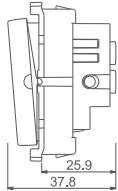

C5141 .01
C5161 .01



C5191 .01
C5171 .01

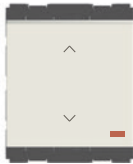

C5241 .01
C5261 .01



C5281 .01
C5291 .01

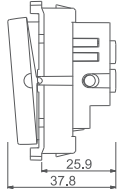

CUBE Series

Switches Frost White

Cat no.	Description	Price (Rs.)
C5110 .01	Switch 6A One-way - 1 Module	155.00
C5111 .01	Switch 6A One-way with indicator - 1 Module	232.00
C5210 .01	Switch 6A Two-way - 1 Module	211.00
C5211 .01	Switch 6A Two-way with indicator - 1 Module	310.00
C5130 .01	Switch 16A One-way - 1 Module	251.00
C5131 .01	Switch 16A One-way with indicator - 1 Module	317.00
C5230 .01	Switch 16A Two-way - 1 Module	268.00
C5231 .01	Switch 16A Two-way with indicator - 1 Module	347.00
C5730 .01	Switch 25A One-way - 1 Module	354.00
C5731 .01	Switch 25A One-way with indicator - 1 Module	417.00
C5310 .01	Switch 6A - Bell - 1 Module	224.00
C5311 .01	Switch 6A - Bell with indicator - 1 Module	309.00
C5140 .01	Palm Switch 6A One-way Single Pole - 2 Module	201.00
C5141 .01	Palm Switch 6A One-way Single Pole with indicator - 2 Module	260.00
C5240 .01	Palm Switch 6A Two-way Single Pole - 2 Module	233.00
C5241 .01	Palm Switch 6A Two-way Single Pole with indicator - 2 Module	330.00
C5160 .01	Palm Switch 16A One-way Single Pole - 2 Module	271.00
C5161 .01	Palm Switch 16A One-way Single Pole with indicator - 2 Module	330.00
C5260 .01	Palm Switch 16A Two-way Single Pole - 2 Module	296.00
C5261 .01	Palm Switch 16A Two-way Single Pole with indicator - 2 Module	385.00
C5180 .01	Palm Switch 6A One-way Double Pole - 2 Module	378.00
C5280 .01	Palm Switch 6A Two-way Double Pole - 2 Module	402.00
C5281 .01	Palm Switch 6A Two-way Double Pole with indicator - 2 Module	447.00
C5191 .01	Palm Switch 16A One-way Double Pole with indicator - 2 Module	526.00
C5291 .01	Palm Switch 16A Two-way Double Pole with indicator - 2 Module	626.00
C5171 .01	Palm Switch 25A One-way Double Pole with indicator - 2 Module	629.00
C5340 .01	Palm Bell Switch Single Pole - 2 Module	278.00
C5341 .01	Palm Bell Switch Single Pole with indicator - 2 Module	359.00
C5441 .01	Switch 16A One-way with 'Geyser' Symbol with indicator - 1 Module	344.00
C5431 .01	Switch 6A One-way with 'Fan' or 'Light' or 'Exhaust' symbol - 1 Module	260.00



C2110.01



C2111.01



C2010.01



C2011.01



C2130.01

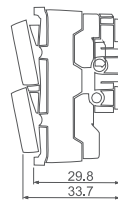

C2131.01



C2030.01



C2031.01



C2140.01



C2141.01

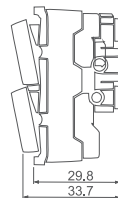

C2040.01



C2041.01

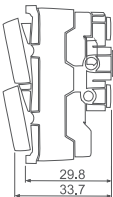

CUBE Series

Twin Switches Frost White

Cat no.	Description	Price (Rs.)
C2110 .01	Twin Switch 6A - 2 Gang - Both switches 1 way - 1 Module	488.00
C2111 .01	Twin Switch 6A - 2 Gang - 1 way + 1 way with indicator - 1 Module	695.00
C2010 .01	Twin Switch 6A - 1 Gang - 2 way + Dummy - 1 Module	543.00
C2011 .01	Twin Switch 6A - 1 Gang - 2 way with indicator + Dummy - 1 Module	761.00
C2130 .01	Twin Switch 16A - 2 Gang - Both switches 1 way - 1 Module	759.00
C2131 .01	Twin Switch 16A - 2 Gang - 1 way + 1 way with indicator - 1 Module	954.00
C2030 .01	Twin Switch 16A - 1 Gang - 2 way + Dummy - 1 Module	719.00
C2031 .01	Twin Switch 16A - 1 Gang - 2 way with indicator + Dummy - 1 Module	922.00
C2140 .01	Twin Switch 6A - 2 Gang - Both Switches Bell - 1 Module	720.00
C2141 .01	Twin Switch 6A - 2 Gang - 1 Bell + 1 Bell with Indicator - 1 Module	951.00
C2040 .01	Twin Switch 6A - 1 Gang - 1 Bell + 1 Dummy - 1 Module	580.00
C2041 .01	Twin Switch 6A - 1 Gang - 1 Bell with Indicator + 1 Dummy - 1 Module	759.00



C5213 .01



C5331 .01



C5332 .01



C5552 .01

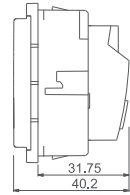

C5212 .01



C5532 .01



C5531 .01



C5752 .01

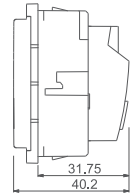

C5010 .01



C5732 .01



C5733 .01



C5902 .01

C5903 .01

C5909 .01

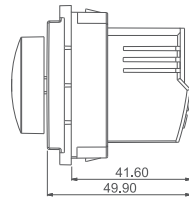

C5904 .01



C5905 .01



C5900 .01

C5910 .01

C5912 .01



C5901 .01

C5911 .01



C5913 .01

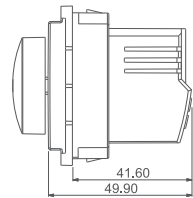

CUBE Series

Sockets Frost White

Cat no.	Description	Price (Rs.)
C5213 .01	Socket 6A 3-Pin-only Shuttered - 2 Module (As per Indian Standard)	303.00
C5332 .01	Socket 16A and 6A 3-Pin Shuttered - 2 Module (As per Indian Standard)	395.00
C5552 .01	Socket 16A and 6A 3-Pin Shuttered - 3 Module (As per Indian Standard)	453.00
C5331 .01	Socket 16A 3-Pin-only Shuttered - 2 Module (As per Indian Standard)	383.00
C5212 .01	Socket 6A 3+2 Pin [Round & Flat] Shuttered - 2 Module *	324.00
C5010 .01	Socket 6A 2 Pin [Round & Flat] - 1 Module *	219.00
C5532 .01	Socket 13A International Multi socket Shuttered - 2 Module *	395.00
C5531 .01	Socket 13A 3-Pin Flat-only Socket Shuttered - 2 Module *	373.00
C5732 .01	Socket 25A and 6A 3-Pin Shuttered - 2 Module *	458.00
C5752 .01	Socket 25A and 6A 3-Pin Shuttered - 3 Module *	540.00
C5733 .01	Socket 25A 3-Pin-only Shuttered - 2 Module *	440.00

Fan Regulators & Dimmers Frost White

C5900 .01	Fan Regulator for 80W fan - Step Type with Bar Knob - 2 Module	1025.00
C5901 .01	Fan Regulator for 80W fan - Step Type with Round Knob - 2 Module	983.00
C5910 .01	Fan Regulator for 120W fan - Step Type with Bar Knob - 2 Module	1127.00
C5911 .01	Fan Regulator for 120W fan - Step Type with Round Knob - 2 Module	1087.00
C5912 .01	Fan Regulator for 120W fan - 8-Step Type with Bar Knob - 2 Module	1173.00
C5913 .01	Fan Regulator for 120W fan - 8-Step Type with Round Knob - 2 Module	1130.00
C5902 .01	Dimmer 500 Watts - 2 Module	824.00
C5903 .01	Dimmer 1000 Watts - 2 Module	1153.00
C5904 .01	Fan Regulator Single Module for 80W Fan - Step Type - 1 Module	674.00
C5905 .01	Dimmer 500 Watts - 1 Module	635.00
C5908 .01	Dimmer for LED Lights 100W (3 wire system) - 1 Module	631.00
C5909 .01	Dimmer for LED Lights Digital Choke 100W (4 wire system) - 2 Module	824.00

* Only for export outside India



C5707 .01
C5708 .01



C5703 .01
C5704 .01
C5705 .01
C5505 .01



C5715 .01
C5716 .01



C5727 .01



C5706 .01
C5709 .01



C5721 .01



C5710 .01

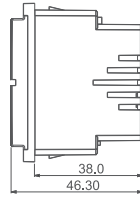

CUBE Series

Acoustic & Optical Signaling Frost White

Cat no.	Description	Price (Rs.)
C5707 .01	Electronic Bell - 2 Module	637.00
C5727 .01	Indicator Light - 1 Module	289.00
C5703 .01	Prismatic Overdoor Bulkhead Indicator - White - 2 Module	580.00
C5704 .01	Prismatic Overdoor Bulkhead Indicator - Green - 2 Module	599.00
C5705 .01	Prismatic Overdoor Bulkhead Indicator - Red - 2 Module	599.00
C5505 .01	Prismatic Overdoor Bulkhead Indicator - Resettable - 2 Module	905.00
C5715 .01	Emergency Light - 2 Module	1549.00
C5706 .01	Speaker for audio music circuit - 2 Module	1127.00
C5716 .01	Night Light with switch and dimming option - 2 Module	983.00
C5721 .01	Step Marker Lamp/ Night Lamp - 2 Module	649.00
C5709 .01	Electronic Buzzer - 2 Module	577.00
C5710 .01	Electronic Buzzer - 1 Module	511.00
C5708 .01	Ultrasonic Mosquito Repellent - 2 Module	912.00



C5712 .01



C5460 .01



C5711 .01



C5262 .01
C5263 .01

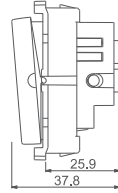

C5450 .01



C5906 .01



C5233 .01



C5232 .01

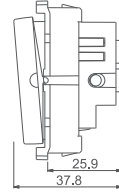

C5718 .01

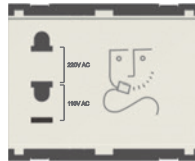

C5723 .01



C5719 .01

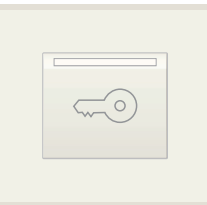
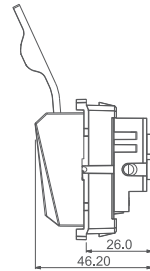

C5717 .01

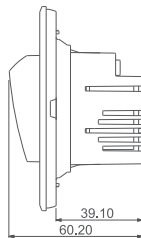

CUBE Series

Hospitality Modules Frost White

Cat no.	Description	Price (Rs.)
C5717 .01	25A Smart Card operated Electronic switch in 2 Module with indicator & exit time delay feature including Smart Card - 2 Module	3010.00
C5718 .01	25A Smart Card operated Electronic switch in 3 Module with indicator & exit time delay feature including Smart Card - 3 Module	2781.00
C5724 .01	Smart Card - Customized	210.00
C5719 .01	25A Key Fob Switch Double Pole with indicator - 2 Module	1355.00
C5720 .01	Key Fob - Customized	214.00
C5723 .01	Shaver Socket 220V/110V - 3 Module	2640.00
C5711 .01	Call Bell Station with Register and provision for External Buzzer - 2M	1497.00
C5712 .01	External Buzzer for Call Bell Station - 2 Module	534.00
C5232 .01	"Do Not Disturb" Switch with indicator - 1 Module	430.00
C5233 .01	"Clean My Room" Switch with indicator - 1 Module	430.00
C5906 .01	Volume Control 100 Ohms 1 Watt - 2 Module	716.00
C5262 .01	Bell Switch with "Do Not Disturb" & "Clean My Room" Indicator - 2M	696.00
C5263 .01	Bell Switch with "DND", "CMR" & Guest is in Indicator - 2M	771.00
C5450 .01	Push Button station (Start - Stop) - 2 Module	600.00
C5460 .01	Curtain Control Switch 6A - 2 Module	665.00



C5729 .01



C5739 .01



C5800 .01
C5809 .01



C5701 .01



C5700 .01



C5802 .01
C5803 .01

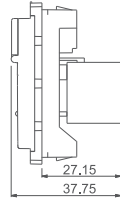

C5725 .01
C5736 .01



C5836 .01



C5797 .01



C5500 .01



C5798 .01



C5820 .01

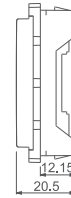

C5936 .01



C5937 .01

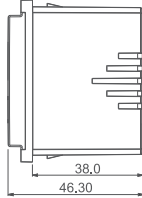

P5131 .01



P5151 .01



P5111 .01

CUBE Series

Communique & Support Modules Frost White

Cat no.	Description	Price (Rs.)
C5797 .01	Coaxial T.V Socket - 1 Module	230.00
C5725 .01	USB Extension Socket - 1 Module	547.00
C5736 .01	USB Charger Socket Outlet A Type - 2.1 Amps - 1 Module	2499.00
C5836 .01	USB Charger Socket Outlet C Type - 2.1 Amps - 1 Module	2764.00
C5936 .01	USB Charger Socket Outlet A+C Type - 2.1 Amps - 1 Module	2987.00
C5937 .01	USB Charger Socket Outlet C+C Type - 3.1 Amps - 1 Module	3448.00
C5729 .01	Computer Monitor Output Socket - 1 Module	381.00
C5739 .01	HDMI Socket - 1 Module	1489.00
C5800 .01	Telephone Socket RJ-11 Double Line Shuttered - 1 Module	220.00
C5820 .01	Twin Telephone Socket RJ-11 - 1 Module	356.00
C5802 .01	Information Socket 6e - UTP Shuttered - 1 Module	814.00
C5803 .01	Information Socket 6a - UTP Shuttered - 1 Module	1374.00
C5701 .01	Triple RCA Audio Visual Socket - 1 Module	754.00
C5500 .01	Cord Outlet - 1 Module	167.00
C5700 .01	Blanking Plate - 1 Module	57.00
C5798 .01	Audio Port / Jack 3.5mm - 1 Module	437.00
C5809 .01	Fitment for RJ-45 Computer Socket Shuttered - 1 Module	246.00

35

Plugs Transparent with Dark Gray

P5111 .01	Plug Top 6A with LED indicator	155.00
P5131 .01	Plug Top 16A with LED indicator	226.00
P5151 .01	Plug Top 25A with LED indicator	281.00



V5110 .01
V5210 .01
V5130 .01
V5230 .01



V5111 .01
V5211 .01
V5131 .01
V5231 .01



V5140 .01
V5240 .01
V5160 .01
V5180 .01



V5141 .01
V5241 .01
V5161 .01
V5261 .01



V5281 .01
V5191 .01
V5291 .01
V5171 .01



V5340 .01
V5341 .01

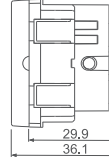

V5901 .01
V5911 .01



V5913 .01



V5900 .01
V5910 .01
V5912 .01



Vertical Switches and Vertical Fan Regulators can be mounted on all types of standard Cube Series Plates. Metal Boxes, Frames and Plates need to be fixed in the vertical position as shown here.

CUBE Series

Vertical Switches Frost White

Cat no.	Description	Price (Rs.)
V5110 .01	Vertical Switches - 2 Gang - Both switches 6A 1 way - 2 Module	372.00
V5111 .01	Vertical Switches - 2 Gang - Both switches 6A 1 way with indicator - 2M	486.00
V5210 .01	Vertical Switches - 2 Gang - Both switches 6A 2 way - 2 Module	449.00
V5211 .01	Vertical Switches - 2 Gang - Both switches 6A 2 way with indicator - 2M	646.00
V5130 .01	Vertical Switches - 2 Gang - Both switches 16A 1 way - 2 Module	531.00
V5131 .01	Vertical Switches - 2 Gang - Both switches 16A 1 way with indicator - 2M	665.00
V5230 .01	Vertical Switches - 2 Gang - Both switches 16A 2 way - 2 Module	562.00
V5231 .01	Vertical Switches - 2 Gang - Both switches 16A 2 way with indicator - 2M	726.00
V5140 .01	Vertical Palm Switch 6A 1 way Single Pole - 2 Module	206.00
V5141 .01	Vertical Palm Switch 6A 1 way Single Pole with indicator - 2 Module	260.00
V5240 .01	Vertical Palm Switch 6A 2 way Single Pole - 2 Module	233.00
V5241 .01	Vertical Palm Switch 6A 2 way Single Pole with indicator - 2 Module	330.00
V5160 .01	Vertical Palm Switch 16A 1 way Single Pole - 2 Module	272.00
V5161 .01	Vertical Palm Switch 16A 1 way Single Pole with indicator - 2 Module	330.00
V5261 .01	Vertical Palm Switch 16A 2 way Single Pole with indicator - 2 Module	384.00
V5180 .01	Vertical Palm Switch 6A 1 way Double Pole - 2 Module	378.00
V5281 .01	Vertical Palm Switch 6A 2 way Double Pole with indicator - 2 Module	447.00
V5191 .01	Vertical Palm Switch 16A 1 way Double Pole with indicator - 2 Module	526.00
V5291 .01	Vertical Palm Switch 16A 2 way Double Pole with indicator - 2 Module	627.00
V5171 .01	Vertical Palm Switch 25A 1 way Double Pole with indicator - 2 Module	629.00
V5340 .01	Vertical Palm Bell Switch Single Pole - 2 Module	278.00
V5341 .01	Vertical Palm Bell Switch Single Pole with indicator - 2 Module	360.00

37

Vertical Fan Regulators & Dimmers Frost White

V5900 .01	Vertical Fan Regulator for 80W fan - Step Type with Bar Knob - 2M	1025.00
V5901 .01	Vertical Fan Regulator for 80W fan - Step Type with Round Knob - 2M	982.00
V5910 .01	Vertical Fan Regulator for 120W fan - Step Type with Bar Knob - 2M	1127.00
V5911 .01	Vertical Fan Regulator for 120W fan - Step Type with Round Knob - 2M	1086.00
V5912 .01	Vertical Fan Regulator for 120W fan - 8-Step Type with Bar Knob - 2M	1173.00
V5913 .01	Vertical Fan Regulator for 120W fan - 8-Step Type with Round Knob-2M	1130.00
V5902 .01	Vertical Dimmer 500 Watts - 2 Module	823.00



C5110 .02
C5130 .02
C5730 .02



C5210 .02
C5230 .02



C5310 .02



C5441 .02

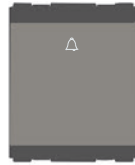

C5340 .02

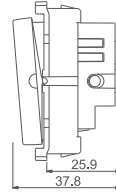

C5111 .02
C5131 .02
C5731 .02



C5211 .02
C5231 .02



C5311 .02



C5431 .02



C5341 .02

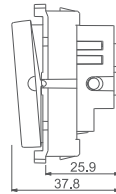

C5140 .02
C5160 .02



C5180 .02

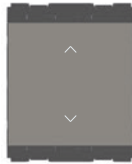

C5240 .02
C5260 .02



C5280 .02

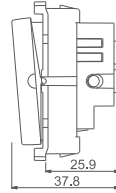

C5141 .02
C5161 .02



C5191 .02
C5171 .02

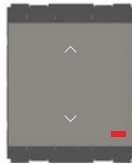

C5241 .02
C5261 .02



C5281 .02
C5291 .02

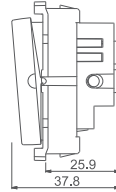

CUBE Series

Switches Quartz Gray

Cat no.	Description	Price (Rs.)
C5110 .02	Switch 6A One-way - 1 Module	191.00
C5111 .02	Switch 6A One-way with indicator - 1 Module	296.00
C5210 .02	Switch 6A Two-way - 1 Module	268.00
C5211 .02	Switch 6A Two-way with indicator - 1 Module	384.00
C5130 .02	Switch 16A One-way - 1 Module	317.00
C5131 .02	Switch 16A One-way with indicator - 1 Module	403.00
C5230 .02	Switch 16A Two-way - 1 Module	339.00
C5231 .02	Switch 16A Two-way with indicator - 1 Module	440.00
C5730 .02	Switch 25A One-way - 1 Module	449.00
C5731 .02	Switch 25A One-way with indicator - 1 Module	520.00
C5310 .02	Switch 6A - Bell - 1 Module	279.00
C5311 .02	Switch 6A - Bell with indicator - 1 Module	392.00
C5140 .02	Palm Switch 6A One-way Single Pole - 2 Module	249.00
C5141 .02	Palm Switch 6A One-way Single Pole with indicator - 2 Module	324.00
C5240 .02	Palm Switch 6A Two-way Single Pole - 2 Module	289.00
C5241 .02	Palm Switch 6A Two-way Single Pole with indicator - 2 Module	410.00
C5160 .02	Palm Switch 16A One-way Single Pole - 2 Module	337.00
C5161 .02	Palm Switch 16A One-way Single Pole with indicator - 2 Module	410.00
C5260 .02	Palm Switch 16A Two-way Single Pole - 2 Module	368.00
C5261 .02	Palm Switch 16A Two-way Single Pole with indicator - 2 Module	480.00
C5180 .02	Palm Switch 6A One-way Double Pole - 2 Module	469.00
C5280 .02	Palm Switch 6A Two-way Double Pole - 2 Module	500.00
C5281 .02	Palm Switch 6A Two-way Double Pole with indicator - 2 Module	555.00
C5191 .02	Palm Switch 16A One-way Double Pole with indicator - 2 Module	654.00
C5291 .02	Palm Switch 16A Two-way Double Pole with indicator - 2 Module	779.00
C5171 .02	Palm Switch 25A One-way Double Pole with indicator - 2 Module	782.00
C5340 .02	Palm Bell Switch Single Pole - 2 Module	347.00
C5341 .02	Palm Bell Switch Single Pole with indicator - 2 Module	445.00
C5441 .02	Switch 16A One-way with 'Geyser' Symbol with indicator - 1 Module	427.00
C5431 .02	Switch 6A One-way with 'Fan' or 'Light' or 'Exhaust' symbol - 1 Module	324.00



C2110.02



C2111.02



C2010.02



C2011.02



C2130.02

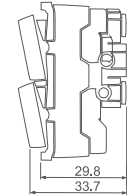

C2131.02



C2030.02



C2031.02



C2140.02



C2141.02

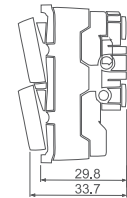

C2040.02



C2041.02

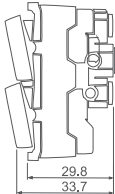

CUBE Series

Twin Switches Quartz Gray

Cat no.	Description	Price (Rs.)
C2110 .02	Twin Switch 6A - 2 Gang - Both switches 1 way - 1 Module	601.00
C2111 .02	Twin Switch 6A - 2 Gang - 1 way + 1 way with indicator - 1 Module	908.00
C2010 .02	Twin Switch 6A - 1 Gang - 2 way + Dummy - 1 Module	698.00
C2011 .02	Twin Switch 6A - 1 Gang - 2 way with indicator + Dummy - 1 Module	979.00
C2130 .02	Twin Switch 16A - 2 Gang - Both switches 1 way - 1 Module	980.00
C2131 .02	Twin Switch 16A - 2 Gang - 1 way + 1 way with indicator - 1 Module	1223.00
C2030 .02	Twin Switch 16A - 1 Gang - 2 way + Dummy - 1 Module	926.00
C2031 .02	Twin Switch 16A - 1 Gang - 2 way with indicator + Dummy - 1 Module	1189.00
C2140 .02	Twin Switch 6A - 2 Gang - Both Switches Bell - 1 Module	921.00
C2141 .02	Twin Switch 6A - 2 Gang - 1 Bell + 1 Bell with Indicator - 1 Module	1217.00
C2040 .02	Twin Switch 6A - 1 Gang - 1 Bell + 1 Dummy - 1 Module	742.00
C2041 .02	Twin Switch 6A - 1 Gang - 1 Bell with Indicator + 1 Dummy - 1 Module	971.00



C5213 .02



C5331 .02



C5332 .02

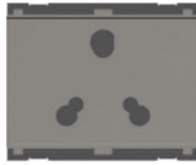

C5552 .02

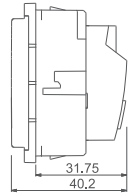

C5212 .02



C5532 .02



C5531 .02



C5752 .02

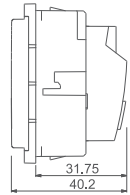

C5010 .02



C5732 .02



C5733 .02



C5902 .02

C5903 .02

C5909 .02

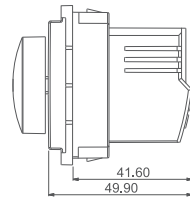

C5904 .02



C5905 .02



C5900 .02

C5910 .02

C5912 .02



C5901 .02

C5911 .02



C5913 .02

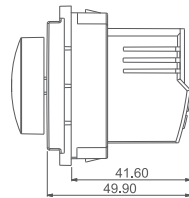

CUBE Series

Sockets Quartz Gray

Cat no.	Description	Price (Rs.)
C5213 .02	Socket 6A 3-Pin-only Shuttered - 2 Module (As per Indian Standard)	374.00
C5332 .02	Socket 16A and 6A 3-Pin Shuttered - 2 Module (As per Indian Standard)	481.00
C5552 .02	Socket 16A and 6A 3-Pin Shuttered - 3 Module (As per Indian Standard)	552.00
C5331 .02	Socket 16A 3-Pin-only Shuttered - 2 Module (As per Indian Standard)	467.00
C5212 .02	Socket 6A 3+2 Pin [Round & Flat] Shuttered - 2 Module *	399.00
C5010 .02	Socket 6A 2 Pin [Round & Flat] - 1 Module *	268.00
C5532 .02	Socket 13A International Multi socket Shuttered - 2 Module *	481.00
C5531 .02	Socket 13A 3-Pin Flat-only Socket Shuttered - 2 Module *	457.00
C5732 .02	Socket 25A and 6A 3-Pin Shuttered - 2 Module *	559.00
C5752 .02	Socket 25A and 6A 3-Pin Shuttered - 3 Module *	659.00
C5733 .02	Socket 25A 3-Pin-only Shuttered - 2 Module *	539.00

Fan Regulators & Dimmers Quartz Gray

C5900 .02	Fan Regulator for 80W fan - Step Type with Bar Knob - 2 Module	1264.00
C5901 .02	Fan Regulator for 80W fan - Step Type with Round Knob - 2 Module	1208.00
C5910 .02	Fan Regulator for 120W fan - Step Type with Bar Knob - 2 Module	1389.00
C5911 .02	Fan Regulator for 120W fan - Step Type with Round Knob - 2 Module	1339.00
C5912 .02	Fan Regulator for 120W fan - 8-Step Type with Bar Knob - 2 Module	1445.00
C5913 .02	Fan Regulator for 120W fan - 8-Step Type with Round Knob - 2 Module	1393.00
C5902 .02	Dimmer 500 Watts - 2 Module	1016.00
C5903 .02	Dimmer 1000 Watts - 2 Module	1424.00
C5904 .02	Fan Regulator Single Module for 80W Fan - Step Type - 1 Module	828.00
C5905 .02	Dimmer 500 Watts - 1 Module	783.00
C5908 .02	Dimmer for LED Lights 100W (3 wire system) - 1 Module	778.00
C5909 .02	Dimmer for LED Lights with Digital Choke 100W (4 wire system) - 2M	1016.00

* Only for export outside India

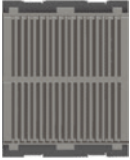

C5707 .02
C5708 .02



C5703 .01
C5704 .01
C5705 .01
C5505 .01



C5715 .02
C5716 .02



C5727 .02

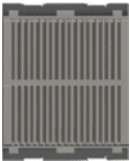

C5706 .02
C5709 .02



C5721 .02



C5710 .02



CUBE Series

Acoustic & Optical Signaling Quartz Gray

Cat no.	Description	Price (Rs.)
C5707 .02	Electronic Bell - 2 Module	794.00
C5727 .02	Indicator Light - 1 Module	359.00
C5703 .01	Prismatic Overdoor Bulkhead Indicator - White - 2 Module	580.00
C5704 .01	Prismatic Overdoor Bulkhead Indicator - Green - 2 Module	599.00
C5705 .01	Prismatic Overdoor Bulkhead Indicator - Red - 2 Module	599.00
C5505 .01	Prismatic Overdoor Bulkhead Indicator - Resettable - 2 Module	905.00
C5715 .02	Emergency Light - 2 Module	1926.00
C5706 .02	Speaker for audio music circuit - 2 Module	1399.00
C5716 .02	Night Light with switch and dimming option - 2 Module	1222.00
C5721 .02	Step Marker Lamp/ Night Lamp - 2 Module	806.00
C5709 .02	Electronic Buzzer - 2 Module	718.00
C5710 .02	Electronic Buzzer - 1 Module	634.00
C5708 .02	Ultrasonic Mosquito Repellent - 2 Module	1135.00



C5712 .02



C5460 .02



C5711 .02



C5262 .02
C5263 .02

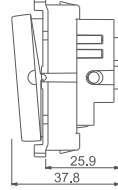

C5450 .02



C5906 .02



C5233 .02



C5232 .02

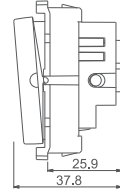

C5718 .02



C5723 .02



C5719 .02

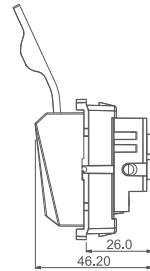

C5717 .02



CUBE Series

Hospitality Modules Quartz Gray

Cat no.	Description	Price (Rs.)
C5717 .02	25A Smart Card operated Electronic switch in 2 Module with indicator & exit time delay feature including Smart Card - 2 Module	3270.00
C5718 .02	25A Smart Card operated Electronic switch in 3 Module with indicator & exit time delay feature including Smart Card - 3 Module	3036.00
C5724 .02	Smart Card - Customized	210.00
C5719 .02	25A Key Fob Switch Double Pole with indicator - 2 Module	1624.00
C5720 .02	Key Fob - Customized	241.00
C5723 .02	Shaver Socket 220V/110V - 3 Module	2885.00
C5711 .02	Call Bell Station with Register and provision for External Buzzer - 2M	1639.00
C5712 .02	External Buzzer for Call Bell Station - 2 Module	651.00
C5232 .02	"Do Not Disturb" Switch with indicator - 1 Module	515.00
C5233 .02	"Clean My Room" Switch with indicator - 1 Module	515.00
C5906 .02	Volume Control 100 Ohms 1 Watt - 2 Module	893.00
C5262 .02	Bell Switch with "Do Not Disturb" & "Clean My Room" Indicator - 2M	877.00
C5263 .02	Bell Switch with "DND", "CMR" & Guest is in Indicator - 2M	946.00
C5450 .02	Push Button station (Start - Stop) - 2 Module	720.00
C5460 .02	Curtain Control Switch 6A - 2 Module	799.00



C5729 .02



C5739 .02



C5800 .02
C5809 .02



C5701 .02



C5700 .02



C5802 .02
C5803 .02

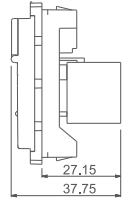

C5725 .02
C5736 .02



C5836 .02



C5797 .02



C5500 .02



C5798 .02



C5820 .02

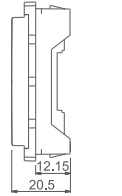

C5936 .02



C5937 .02

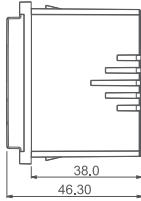

CUBE Series

Communiqué & Support Modules Quartz Gray

Cat no.	Description	Price (Rs.)
C5797 .02	Coaxial T.V Socket - 1 Module	277.00
C5725 .02	USB Extension Socket - 1 Module	656.00
C5736 .02	USB Charger Socket Outlet A Type - 2.1 Amps - 1 Module	2998.00
C5836 .02	USB Charger Socket Outlet C Type - 2.1 Amps - 1 Module	3316.00
C5936 .02	USB Charger Socket Outlet A+C Type - 2.1 Amps - 1 Module	3583.00
C5937 .02	USB Charger Socket Outlet C+C Type - 3.1 Amps - 1 Module	4108.00
C5729 .02	Computer Monitor Output Socket - 1 Module	457.00
C5739 .02	HDMI Socket - 1 Module	1787.00
C5800 .02	Telephone Socket RJ-11 Double Line Shuttered - 1 Module	266.00
C5820 .02	Twin Telephone Socket RJ-11 - 1 Module	427.00
C5802 .02	Information Socket 6e - UTP Shuttered - 1 Module	976.00
C5803 .02	Information Socket 6a - UTP Shuttered - 1 Module	1648.00
C5701 .02	Triple RCA Audio Visual Socket - 1 Module	903.00
C5500 .02	Cord Outlet - 1 Module	200.00
C5700 .02	Blanking Plate - 1 Module	71.00
C5798 .02	Audio Port / Jack 3.5mm - 1 Module	523.00
C5809 .02	Fitment for RJ-45 Computer Socket Shuttered - 1 Module	295.00



V5110 .02
V5210 .02
V5130 .02
V5230 .02



V5111 .02
V5211 .02
V5131 .02
V5231 .02



V5140 .02
V5240 .02
V5160 .02
V5180 .02



V5141 .02
V5241 .02
V5161 .02
V5261 .02



V5281 .02
V5191 .02
V5291 .02
V5171 .02



V5340 .02
V5341 .02

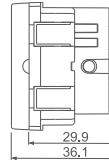

V5901 .02
V5911 .02



V5913 .02

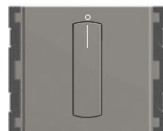

V5900 .02
V5910 .02
V5912 .02



Vertical Switches and Vertical Fan Regulators can be mounted on all types of standard Cube Series Plates. Metal Boxes, Frames and Plates need to be fixed in the vertical position as shown here.

CUBE Series

Vertical Switches Quartz Gray

Cat no.	Description	Price (Rs.)
V5110 .02	Vertical Switches - 2 Gang - Both switches 6A 1 way - 2 Module	466.00
V5111 .02	Vertical Switches - 2 Gang - Both switches 6A 1 way with indicator - 2M	606.00
V5210 .02	Vertical Switches - 2 Gang - Both switches 6A 2 way - 2 Module	561.00
V5211 .02	Vertical Switches - 2 Gang - Both switches 6A 2 way with indicator - 2M	791.00
V5130 .02	Vertical Switches - 2 Gang - Both switches 16A 1 way - 2 Module	660.00
V5131 .02	Vertical Switches - 2 Gang - Both switches 16A 1 way with indicator - 2M	828.00
V5230 .02	Vertical Switches - 2 Gang - Both switches 16A 2 way - 2 Module	698.00
V5231 .02	Vertical Switches - 2 Gang - Both switches 16A 2 way with indicator - 2M	904.00
V5140 .02	Vertical Palm Switch 6A 1 way Single Pole - 2 Module	255.00
V5141 .02	Vertical Palm Switch 6A 1 way Single Pole with indicator - 2 Module	324.00
V5240 .02	Vertical Palm Switch 6A 2 way Single Pole - 2 Module	289.00
V5241 .02	Vertical Palm Switch 6A 2 way Single Pole with indicator - 2 Module	410.00
V5160 .02	Vertical Palm Switch 16A 1 way Single Pole - 2 Module	337.00
V5161 .02	Vertical Palm Switch 16A 1 way Single Pole with indicator - 2 Module	410.00
V5261 .02	Vertical Palm Switch 16A 2 way Single Pole with indicator - 2 Module	480.00
V5180 .02	Vertical Palm Switch 6A 1 way Double Pole - 2 Module	469.00
V5281 .02	Vertical Palm Switch 6A 2 way Double Pole with indicator - 2 Module	555.00
V5191 .02	Vertical Palm Switch 16A 1 way Double Pole with indicator - 2 Module	655.00
V5291 .02	Vertical Palm Switch 16A 2 way Double Pole with indicator - 2 Module	780.00
V5171 .02	Vertical Palm Switch 25A 1 way Double Pole with indicator - 2 Module	782.00
V5340 .02	Vertical Palm Bell Switch Single Pole - 2 Module	345.00
V5341 .02	Vertical Palm Bell Switch Single Pole with indicator - 2 Module	445.00

Vertical Fan Regulators & Dimmers Quartz Gray

V5900 .02	Vertical Fan Regulator for 80W fan - Step Type with Bar Knob - 2M	1265.00
V5901 .02	Vertical Fan Regulator for 80W fan - Step Type with Round Knob - 2M	1208.00
V5910 .02	Vertical Fan Regulator for 120W fan - Step Type with Bar Knob - 2M	1390.00
V5911 .02	Vertical Fan Regulator for 120W fan - Step Type with Round Knob - 2M	1339.00
V5912 .02	Vertical Fan Regulator for 120W fan - 8-Step Type with Bar Knob - 2M	1445.00
V5913 .02	Vertical Fan Regulator for 120W fan - 8-Step Type with Round Knob-2M	1393.00
V5902 .02	Vertical Dimmer 500 Watts - 2 Module	1016.00



C5110 .17
C5130 .17
C5730 .17



C5210 .17
C5230 .17



C5310 .17



C5441 .17

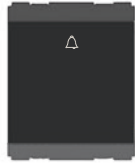

C5340 .17

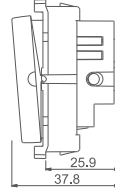

C5111 .17
C5131 .17
C5731 .17



C5211 .17
C5231 .17



C5311 .17



C5431 .17

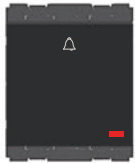

C5341 .17

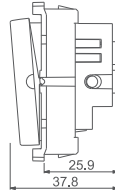

C5140 .17
C5160 .17



C5180 .17



C5240 .17
C5260 .17



C5280 .17

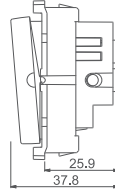

C5141 .17
C5161 .17



C5191 .17
C5171 .17

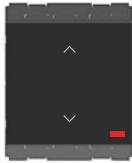

C5241 .17
C5261 .17



C5281 .17
C5291 .17

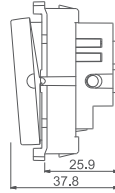

CUBE Series

Switches Charcoal Black

Cat no.	Description	Price (Rs.)
C5110 .17	Switch 6A One-way - 1 Module	207.00
C5111 .17	Switch 6A One-way with indicator - 1 Module	331.00
C5210 .17	Switch 6A Two-way - 1 Module	302.00
C5211 .17	Switch 6A Two-way with indicator - 1 Module	441.00
C5130 .17	Switch 16A One-way - 1 Module	358.00
C5131 .17	Switch 16A One-way with indicator - 1 Module	453.00
C5230 .17	Switch 16A Two-way - 1 Module	383.00
C5231 .17	Switch 16A Two-way with indicator - 1 Module	494.00
C5730 .17	Switch 25A One-way - 1 Module	504.00
C5731 .17	Switch 25A One-way with indicator - 1 Module	594.00
C5310 .17	Switch 6A - Bell - 1 Module	319.00
C5311 .17	Switch 6A - Bell with indicator - 1 Module	441.00
C5140 .17	Palm Switch 6A One-way Single Pole - 2 Module	273.00
C5141 .17	Palm Switch 6A One-way Single Pole with indicator - 2 Module	355.00
C5240 .17	Palm Switch 6A Two-way Single Pole - 2 Module	316.00
C5241 .17	Palm Switch 6A Two-way Single Pole with indicator - 2 Module	448.00
C5160 .17	Palm Switch 16A One-way Single Pole - 2 Module	370.00
C5161 .17	Palm Switch 16A One-way Single Pole with indicator - 2 Module	448.00
C5260 .17	Palm Switch 16A Two-way Single Pole - 2 Module	402.00
C5261 .17	Palm Switch 16A Two-way Single Pole with indicator - 2 Module	523.00
C5180 .17	Palm Switch 6A One-way Double Pole - 2 Module	515.00
C5280 .17	Palm Switch 6A Two-way Double Pole - 2 Module	548.00
C5281 .17	Palm Switch 6A Two-way Double Pole with indicator - 2 Module	607.00
C5191 .17	Palm Switch 16A One-way Double Pole with indicator - 2 Module	716.00
C5291 .17	Palm Switch 16A Two-way Double Pole with indicator - 2 Module	852.00
C5171 .17	Palm Switch 25A One-way Double Pole with indicator - 2 Module	855.00
C5340 .17	Palm Bell Switch Single Pole - 2 Module	378.00
C5341 .17	Palm Bell Switch Single Pole with indicator - 2 Module	488.00
C5441 .17	Switch 16A One-way with 'Geyser' Symbol with indicator - 1 Module	468.00
C5431 .17	Switch 6A One-way with 'Fan' or 'Light' or 'Exhaust' symbol - 1 Module	355.00



C2110.17



C2111.17



C2010.17

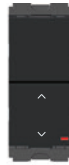

C2011.17



C2130.17

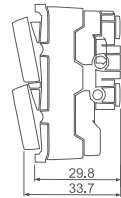

C2131.17



C2030.17



C2031.17



C2140.17



C2141.17

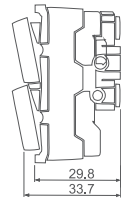

C2040.17



C2041.17

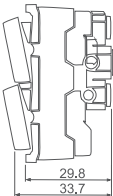

CUBE Series

Twin Switches Charcoal Black

Cat no.	Description	Price (Rs.)
C2110 .17	Twin Switch 6A - 2 Gang - Both switches 1 way - 1 Module	651.00
C2111 .17	Twin Switch 6A - 2 Gang - 1 way + 1 way with indicator - 1 Module	983.00
C2010 .17	Twin Switch 6A - 1 Gang - 2 way + Dummy - 1 Module	753.00
C2011 .17	Twin Switch 6A - 1 Gang - 2 way with indicator + Dummy - 1 Module	1056.00
C2130 .17	Twin Switch 16A - 2 Gang - Both switches 1 way - 1 Module	1056.00
C2131 .17	Twin Switch 16A - 2 Gang - 1 way + 1 way with indicator - 1 Module	1325.00
C2030 .17	Twin Switch 16A - 1 Gang - 2 way + Dummy - 1 Module	1002.00
C2031 .17	Twin Switch 16A - 1 Gang - 2 way with indicator + Dummy - 1 Module	1265.00
C2140 .17	Twin Switch 6A - 2 Gang - Both Switches Bell - 1 Module	993.00
C2141 .17	Twin Switch 6A - 2 Gang - 1 Bell + 1 Bell with Indicator - 1 Module	1312.00
C2040 .17	Twin Switch 6A - 1 Gang - 1 Bell + 1 Dummy - 1 Module	800.00
C2041 .17	Twin Switch 6A - 1 Gang - 1 Bell with Indicator + 1 Dummy - 1 Module	1047.00



C5213 .17



C5331 .17



C5332 .17



C5552 .17

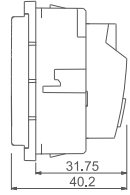

C5212 .17



C5532 .17



C5531 .17



C5752 .17

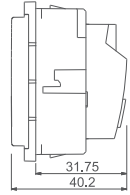

C5010 .17



C5732 .17



C5733 .17



C5902 .17
C5903 .17
C5909 .17

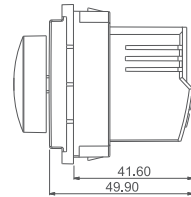

C5904 .17



C5905 .17
C5908 .17



C5900 .17
C5910 .17
C5912 .17



C5901 .17
C5911 .17



C5913 .17

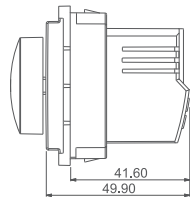

CUBE Series

Sockets Charcoal Black

Cat no.	Description	Price (Rs.)
C5213 .17	Socket 6A 3-Pin-only Shuttered - 2 Module (As per Indian Standard)	411.00
C5332 .17	Socket 16A and 6A 3-Pin Shuttered - 2 Module (As per Indian Standard)	532.00
C5552 .17	Socket 16A and 6A 3-Pin Shuttered - 3 Module (As per Indian Standard)	612.00
C5331 .17	Socket 16A 3-Pin-only Shuttered - 2 Module (As per Indian Standard)	516.00
C5212 .17	Socket 6A 3+2 Pin [Round & Flat] Shuttered - 2 Module *	437.00
C5010 .17	Socket 6A 2 Pin [Round & Flat] - 1 Module *	297.00
C5532 .17	Socket 13A International Multi socket Shuttered - 2 Module *	532.00
C5531 .17	Socket 13A 3-Pin Flat-only Socket Shuttered - 2 Module *	504.00
C5732 .17	Socket 25A and 6A 3-Pin Shuttered - 2 Module *	617.00
C5752 .17	Socket 25A and 6A 3-Pin Shuttered - 3 Module *	728.00
C5733 .17	Socket 25A 3-Pin-only Shuttered - 2 Module *	594.00

Fan Regulators & Dimmers Charcoal Black

C5900 .17	Fan Regulator for 80W fan - Step Type with Bar Knob - 2 Module	1394.00
C5901 .17	Fan Regulator for 80W fan - Step Type with Round Knob - 2 Module	1337.00
C5910 .17	Fan Regulator for 120W fan - Step Type with Bar Knob - 2 Module	1534.00
C5911 .17	Fan Regulator for 120W fan - Step Type with Round Knob - 2 Module	1476.00
C5912 .17	Fan Regulator for 120W fan - 8-Step Type with Bar Knob - 2 Module	1595.00
C5913 .17	Fan Regulator for 120W fan - 8-Step Type with Round Knob - 2 Module	1535.00
C5902 .17	Dimmer 500 Watts - 2 Module	1121.00
C5903 .17	Dimmer 1000 Watts - 2 Module	1569.00
C5904 .17	Fan Regulator Single Module for 80W Fan - Step Type - 1 Module	918.00
C5905 .17	Dimmer 500 Watts - 1 Module	864.00
C5908 .17	Dimmer for LED Lights 100W (3 wire system) - 1 Module	860.00
C5909 .17	Dimmer for LED Lights with Digital Choke 100W (4 wire system) - 2M	1121.00

* Only for export outside India

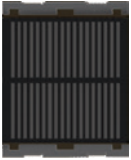

C5707 .17
C5708 .17



C5703 .01
C5704 .01
C5705 .01
C5505 .01



C5715 .17
C5716 .17



C5727 .17

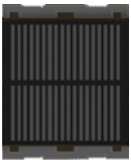

C5706 .17
C5709 .17



C5721 .17



C5710 .17



CUBE Series

Acoustic & Optical Signaling Charcoal Black

Cat no.	Description	Price (Rs.)
C5707 .17	Electronic Bell - 2 Module	860.00
C5727 .17	Indicator Light - 1 Module	391.00
C5703 .01	Prismatic Overdoor Bulkhead Indicator - White - 2 Module	580.00
C5704 .01	Prismatic Overdoor Bulkhead Indicator - Green - 2 Module	599.00
C5705 .01	Prismatic Overdoor Bulkhead Indicator - Red - 2 Module	599.00
C5505 .01	Prismatic Overdoor Bulkhead Indicator - Resettable - 2 Module	905.00
C5715 .17	Emergency Light - 2 Module	2087.00
C5706 .17	Speaker for audio music circuit - 2 Module	1518.00
C5716 .17	Night Light with switch and dimming option - 2 Module	1324.00
C5721 .17	Step Marker Lamp/ Night Lamp - 2 Module	875.00
C5709 .17	Electronic Buzzer - 2 Module	778.00
C5710 .17	Electronic Buzzer - 1 Module	690.00
C5708 .17	Ultrasonic Mosquito Repellent - 2 Module	1229.00

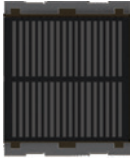

C5712 .17



C5460 .17

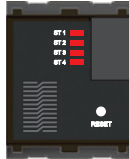

C5711 .17



C5262 .17
C5263 .17

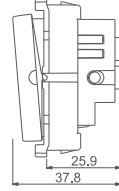

C5450 .17

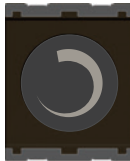

C5906 .17



C5233 .17



C5232 .17

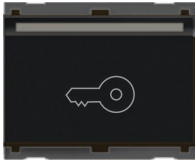
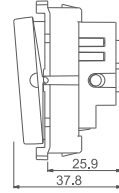

C5718 .17

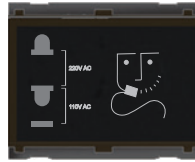

C5723 .17



C5719 .17

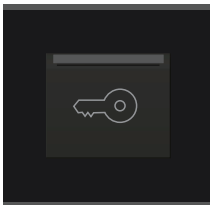
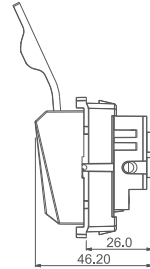

C5717 .17

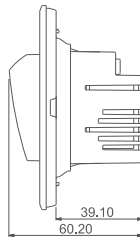

CUBE Series

Hospitality Modules Charcoal Black

Cat no.	Description	Price (Rs.)
C5717 .17	25A Smart Card operated Electronic switch in 2 Module with indicator & exit time delay feature including Smart Card - 2 Module	3862.00
C5718 .17	25A Smart Card operated Electronic switch in 3 Module with indicator & exit time delay feature including Smart Card - 3 Module	3586.00
C5724 .17	Smart Card - Customized	271.00
C5719 .17	25A Key Fob Switch Double Pole with indicator - 2 Module	1747.00
C5720 .17	Key Fob - Customized	278.00
C5723 .17	Shaver Socket 220V/110V - 3 Module	3404.00
C5711 .17	Call Bell Station with Register and provision for External Buzzer - 2M	1928.00
C5712 .17	External Buzzer for Call Bell Station - 2 Module	708.00
C5232 .17	"Do Not Disturb" Switch with indicator - 1 Module	554.00
C5233 .17	"Clean My Room" Switch with indicator - 1 Module	554.00
C5906 .17	Volume Control 100 Ohms 1 Watt - 2 Module	923.00
C5262 .17	Bell Switch with "Do Not Disturb" & "Clean My Room" Indicator - 2M	897.00
C5263 .17	Bell Switch with "DND", "CMR" & Guest is in Indicator - 2M	1023.00
C5450 .17	Push Button station (Start - Stop) - 2 Module	774.00
C5460 .17	Curtain Control Switch 6A - 2 Module	855.00



C5729 .17



C5739 .17



C5800 .17
C5809 .17



C5701 .17



C5700 .17



C5802 .17
C5803 .17

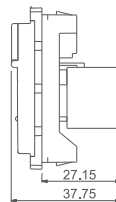

C5725 .17
C5736 .17



C5836 .17



C5797 .17



C5500 .17



C5798 .17



C5820 .17

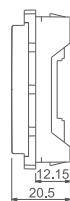

C5936 .17



C5937 .17



C5110 .20



C5111 .20
C5131 .20
C5731 .20



C5171 .20

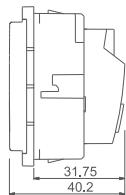

C5212 .20

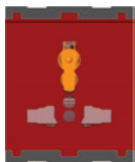

C5532 .20

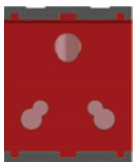

C5332 .20

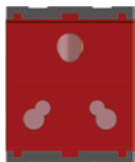

C5732 .20

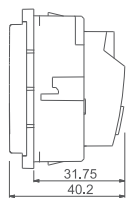

CUBE Series

Communiqué & Support Modules Charcoal Black

Cat no.	Description	Price (Rs.)
C5797 .17	Coaxial T.V Socket - 1 Module	300.00
C5725 .17	USB Extension Socket - 1 Module	712.00
C5736 .17	USB Charger Socket Outlet A Type - 2.1 Amps - 1 Module	3248.00
C5836 .17	USB Charger Socket Outlet C Type - 2.1 Amps - 1 Module	3592.00
C5936 .17	USB Charger Socket Outlet A+C Type - 2.1 Amps - 1 Module	3882.00
C5937 .17	USB Charger Socket Outlet C+C Type - 3.1 Amps - 1 Module	4448.00
C5729 .17	Computer Monitor Output Socket - 1 Module	495.00
C5739 .17	HDMI Socket - 1 Module	1936.00
C5800 .17	Telephone Socket RJ-11 Double Line Shuttered - 1 Module	287.00
C5820 .17	Twin Telephone Socket RJ-11 - 1 Module	463.00
C5802 .17	Information Socket 6e - UTP Shuttered - 1 Module	1061.00
C5803 .17	Information Socket 6a - UTP Shuttered - 1 Module	1787.00
C5701 .17	Triple RCA Audio Visual Socket - 1 Module	981.00
C5500 .17	Cord Outlet - 1 Module	218.00
C5700 .17	Blanking Plate - 1 Module	78.00
C5798 .17	Audio Port / Jack 3.5mm - 1 Module	568.00
C5809 .17	Fitment for RJ-45 Computer Socket Shuttered - 1 Module	320.00

63

Dedicated Modules Scarlet Red

C5110 .20	Switch 6A One-way - 1 Module	252.00
C5111 .20	Switch 6A One-way with indicator - 1 Module	331.00
C5131 .20	Switch 16A One-way with indicator - 1 Module	453.00
C5731 .20	Switch 25A One-way with indicator - 1 Module	594.00
C5171 .20	Palm Switch 25A One-way Double Pole with indicator - 2 Module	855.00
C5212 .20	Socket 6A 3+2 Pin [Round & Flat] Shuttered - 2 Module *	437.00
C5532 .20	Socket 13A International Multi socket Shuttered - 2 Module *	532.00
C5332 .20	Socket 16A and 6A 3-Pin Shuttered - 2 Module (As per Indian Standard)	532.00
C5732 .20	Socket 25A and 6A 3-Pin Shuttered - 2 Module *	616.00

* Only for export outside India



V5110 .17
V5210 .17
V5130 .17
V5230 .17



V5111 .17
V5211 .17
V5131 .17
V5231 .17



V5140 .17
V5240 .17
V5160 .17
V5180 .17

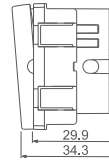

V5141 .17
V5241 .17
V5161 .17
V5261 .17



V5281 .17
V5191 .17
V5291 .17
V5171 .17



V5340 .17
V5341 .17

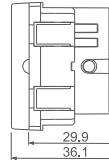

V5901 .17
V5911 .17



V5913 .17



V5900 .17
V5910 .17
V5912 .17



Vertical Switches and Vertical Fan Regulators can be mounted on all types of standard Cube Series Plates. Metal Boxes, Frames and Plates need to be fixed in the vertical position as shown here.

CUBE Series

Vertical Switches Charcoal Black

Cat no.	Description	Price (Rs.)
V5110 .17	Vertical Switches - 2 Gang - Both switches 6A 1 way - 2 Module	504.00
V5111 .17	Vertical Switches - 2 Gang - Both switches 6A 1 way with indicator - 2M	660.00
V5210 .17	Vertical Switches - 2 Gang - Both switches 6A 2 way - 2 Module	614.00
V5211 .17	Vertical Switches - 2 Gang - Both switches 6A 2 way with indicator - 2M	879.00
V5130 .17	Vertical Switches - 2 Gang - Both switches 16A 1 way - 2 Module	726.00
V5131 .17	Vertical Switches - 2 Gang - Both switches 16A 1 way with indicator - 2M	904.00
V5230 .17	Vertical Switches - 2 Gang - Both switches 16A 2 way - 2 Module	765.00
V5231 .17	Vertical Switches - 2 Gang - Both switches 16A 2 way with indicator - 2M	988.00
V5140 .17	Vertical Palm Switch 6A 1 way Single Pole - 2 Module	279.00
V5141 .17	Vertical Palm Switch 6A 1 way Single Pole with indicator - 2 Module	355.00
V5240 .17	Vertical Palm Switch 6A 2 way Single Pole - 2 Module	317.00
V5241 .17	Vertical Palm Switch 6A 2 way Single Pole with indicator - 2 Module	448.00
V5160 .17	Vertical Palm Switch 16A 1 way Single Pole - 2 Module	369.00
V5161 .17	Vertical Palm Switch 16A 1 way Single Pole with indicator - 2 Module	448.00
V5261 .17	Vertical Palm Switch 16A 2 way Single Pole with indicator - 2 Module	523.00
V5180 .17	Vertical Palm Switch 6A 1 way Double Pole - 2 Module	515.00
V5281 .17	Vertical Palm Switch 6A 2 way Double Pole with indicator - 2 Module	607.00
V5191 .17	Vertical Palm Switch 16A 1 way Double Pole with indicator - 2 Module	716.00
V5291 .17	Vertical Palm Switch 16A 2 way Double Pole with indicator - 2 Module	852.00
V5171 .17	Vertical Palm Switch 25A 1 way Double Pole with indicator - 2 Module	855.00
V5340 .17	Vertical Palm Bell Switch Single Pole - 2 Module	378.00
V5341 .17	Vertical Palm Bell Switch Single Pole with indicator - 2 Module	488.00

Vertical Fan Rgulators & Dimmers Charcoal Black

V5900 .17	Vertical Fan Regulator for 80W fan - Step Type with Bar Knob - 2M	1394.00
V5901 .17	Vertical Fan Regulator for 80W fan - Step Type with Round Knob - 2M	1337.00
V5910 .17	Vertical Fan Regulator for 120W fan - Step Type with Bar Knob - 2M	1532.00
V5911 .17	Vertical Fan Regulator for 120W fan - Step Type with Round Knob - 2M	1478.00
V5912 .17	Vertical Fan Regulator for 120W fan - 8-Step Type with Bar Knob - 2M	1595.00
V5913 .17	Vertical Fan Regulator for 120W fan - 8-Step Type with Round Knob-2M	1535.00
V5902 .17	Vertical Dimmer 500 Watts - 2 Module	1121.00



C5101 .01 C5101 .16
 C5101 .02 C5101 .17
 C5101 .03 C5101 .25



C5102 .01 C5102 .16
 C5102 .02 C5102 .17
 C5102 .03 C5102 .25



C5103 .01 C5103 .16
 C5103 .02 C5103 .17
 C5103 .03 C5103 .25

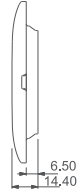

C5104 .01 C5104 .16
 C5104 .02 C5104 .17
 C5104 .03 C5104 .25



C5106 .01 C5106 .16
 C5106 .02 C5106 .17
 C5106 .03 C5106 .25

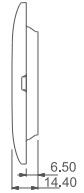

66



C5108 .01 C5108 .16
 C5108 .02 C5108 .17
 C5108 .03 C5108 .25

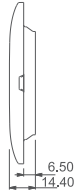

C5109 .01 C5109 .16
 C5109 .02 C5109 .17
 C5109 .03 C5109 .25



C5112 .01 C5112 .16
 C5112 .02 C5112 .17
 C5112 .03 C5112 .25

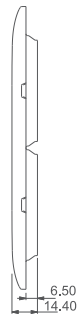

Image for 14M Plate and 21M Plate are not shown here

CUBE Series

Smart plates with frames Frost White, Quartz Gray and Ice Silver

Description	Frost White		Quartz Gray		Ice Silver	
	Cat no.	Price	Cat no.	Price	Cat no.	Price
1M Plate	C5101 .01	153.00	C5101 .02	241.00	C5101 .03	241.00
2M Plate	C5102 .01	161.00	C5102 .02	254.00	C5102 .03	254.00
3M Plate	C5103 .01	176.00	C5103 .02	277.00	C5103 .03	277.00
4M Plate	C5104 .01	187.00	C5104 .02	296.00	C5104 .03	296.00
6M Plate	C5106 .01	335.00	C5106 .02	534.00	C5106 .03	534.00
8M Plate	C5108 .01	370.00	C5108 .02	588.00	C5108 .03	588.00
8M (V) Plate	C5109 .01	432.00	C5109 .02	684.00	C5109 .03	684.00
12M Plate	C5112 .01	524.00	C5112 .02	832.00	C5112 .03	832.00
14M Plate	C5114 .01	599.00	C5114 .02	958.00	C5114 .03	958.00
21M Plate	C5121 .01	757.00	C5121 .02	1387.00	C5121 .03	1387.00

67

Smart plates with frames Matt Gold, Charcoal Black and Cocoa Brown

Description	Matt Gold		Charcoal Black		Cocoa Brown	
	Cat no.	Price	Cat no.	Price	Cat no.	Price
1M Plate	C5101 .16	289.00	C5101 .17	292.00	C5101 .25	292.00
2M Plate	C5102 .16	306.00	C5102 .17	308.00	C5102 .25	308.00
3M Plate	C5103 .16	333.00	C5103 .17	336.00	C5103 .25	336.00
4M Plate	C5104 .16	356.00	C5104 .17	359.00	C5104 .25	359.00
6M Plate	C5106 .16	641.00	C5106 .17	647.00	C5106 .25	647.00
8M Plate	C5108 .16	706.00	C5108 .17	711.00	C5108 .25	711.00
8M (V) Plate	C5109 .16	822.00	C5109 .17	828.00	C5109 .25	828.00
12M Plate	C5112 .16	998.00	C5112 .17	1008.00	C5112 .25	1008.00
14M Plate	C5114 .16	1150.00	C5114 .17	1160.00	C5114 .25	1160.00
21M Plate	C5121 .16	1665.00	C5121 .17	1680.00	C5121 .25	1680.00



C5401 .01 C5401 .16
 C5401 .02 C5401 .17
 C5401 .03 C5401 .25



C5402 .01 C5402 .16
 C5402 .02 C5402 .17
 C5402 .03 C5402 .25



C5403 .01 C5403 .16
 C5403 .02 C5403 .17
 C5403 .03 C5403 .25

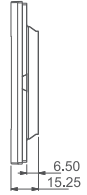

C5404 .01 C5404 .16
 C5404 .02 C5404 .17
 C5404 .03 C5404 .25



C5406 .01 C5406 .16
 C5406 .02 C5406 .17
 C5406 .03 C5406 .25

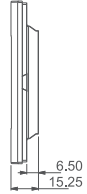

C5408 .01 C5408 .16
 C5408 .02 C5408 .17
 C5408 .03 C5408 .25

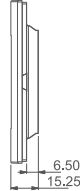

C5409 .01 C5409 .16
 C5409 .02 C5409 .17
 C5409 .03 C5409 .25



C5412 .01 C5412 .16
 C5412 .02 C5412 .17
 C5412 .03 C5412 .25

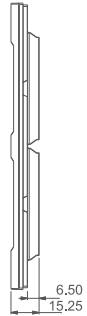

Images for 14M Plate, 16M Plate and 21M Plate are not shown here

CUBE Series

Vector plates with frames Frost White, Quartz Gray and Ice Silver

Description	Frost White		Quartz Gray		Ice Silver	
	Cat no.	Price	Cat no.	Price	Cat no.	Price
1M Plate	C5401 .01	166.00	C5401 .02	253.00	C5401 .03	253.00
2M Plate	C5402 .01	173.00	C5402 .02	266.00	C5402 .03	266.00
3M Plate	C5403 .01	189.00	C5403 .02	293.00	C5403 .03	293.00
4M Plate	C5404 .01	202.00	C5404 .02	312.00	C5404 .03	312.00
6M Plate	C5406 .01	364.00	C5406 .02	561.00	C5406 .03	561.00
8M Plate	C5408 .01	400.00	C5408 .02	618.00	C5408 .03	618.00
8M (V) Plate	C5409 .01	466.00	C5409 .02	719.00	C5409 .03	719.00
12M Plate	C5412 .01	569.00	C5412 .02	874.00	C5412 .03	874.00
14M Plate	C5414 .01	662.00	C5414 .02	1019.00	C5414 .03	1019.00
16M Plate	C5416 .01	697.00	C5416 .02	1073.00	C5416 .03	1073.00
21M Plate	C5421 .01	836.00	C5421 .02	1478.00	C5421 .03	1478.00

69

Vector plates with frames Matt Gold, Charcoal Black and Cocoa Brown

Description	Matt Gold		Charcoal Black		Cocoa Brown	
	Cat no.	Price	Cat no.	Price	Cat no.	Price
1M Plate	C5401 .16	304.00	C5401 .17	312.00	C5401 .25	312.00
2M Plate	C5402 .16	338.00	C5402 .17	350.00	C5402 .25	350.00
3M Plate	C5403 .16	363.00	C5403 .17	380.00	C5403 .25	380.00
4M Plate	C5404 .16	392.00	C5404 .17	409.00	C5404 .25	409.00
6M Plate	C5406 .16	673.00	C5406 .17	698.00	C5406 .25	698.00
8M Plate	C5408 .16	743.00	C5408 .17	753.00	C5408 .25	753.00
8M (V) Plate	C5409 .16	861.00	C5409 .17	908.00	C5409 .25	908.00
12M Plate	C5412 .16	1049.00	C5412 .17	1085.00	C5412 .25	1085.00
14M Plate	C5414 .16	1224.00	C5414 .17	1248.00	C5414 .25	1248.00
16M Plate	C5416 .16	1290.00	C5416 .17	1363.00	C5416 .25	1363.00
21M Plate	C5421 .16	1773.00	C5421 .17	1866.00	C5421 .25	1866.00



C6401 .01 C6401 .03
C6401 .02 C6401 .16



C6402 .01 C6402 .03
C6402 .02 C6402 .16



C6403 .01 C6403 .03
C6403 .02 C6403 .16

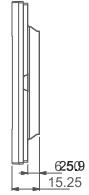

C6404 .01 C6404 .03
C6404 .02 C6404 .16



C6406 .01 C6406 .03
C6406 .02 C6406 .16

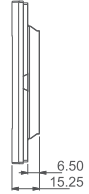

70



C6408 .01 C6408 .03
C6408 .02 C6408 .16

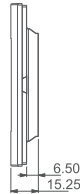

C6409 .01 C6409 .03
C6409 .02 C6409 .16



C6412 .01 C6412 .03
C6412 .02 C6412 .16

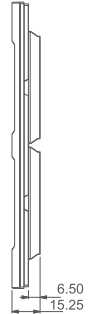

Images for 14M Plate, 16M Plate and 21M Plate are not shown here

CUBE Series

Flat'5 plates with frames Frost White and Quartz Gray

Description	Cat no.	Price	Frost White		Quartz Gray	
			Cat no.	Price	Cat no.	Price
1M Plate - for 75mm x 75mm box (3x3)			C6401 .01	227.00	C6401 .02	401.00
2M Plate - for 75mm x 75mm box (3x3)			C6402 .01	240.00	C6402 .02	436.00
3M Plate - for 100mm x 75mm box (4x3)			C6403 .01	266.00	C6403 .02	482.00
4M Plate - for 135mm x 75mm box (5x3)			C6404 .01	284.00	C6404 .02	512.00
6M Plate - for 210mm x 75mm box (8x3)			C6406 .01	511.00	C6406 .02	926.00
8M Plate - for 230/210 x 75mm box (9x3 or 8x3)			C6408 .01	568.00	C6408 .02	1027.00
8M (V) Plate - for 135mm x 140mm box (5x5)			C6409 .01	755.00	C6409 .02	1325.00
12M Plate - for 140mm x 210mm box (8x6)			C6412 .01	873.00	C6412 .02	1583.00
14M Plate - for 140mm x 210mm box (8x6)			C6414 .01	1029.00	C6414 .02	1863.00
16M Plate - for 230x145mm box (10x6 or 9x6)			C6416 .01	1152.00	C6416 .02	2092.00
21M Plate - for 210mm x 210mm box (8x8)			C6421 .01	1319.00	C6421 .02	2403.00

71

Flat'5 plates with frames Ice Silver and Matt Gold

Description	Cat no.	Price	Ice Silver		Matt Gold	
			Cat no.	Price	Cat no.	Price
1M Plate - for 75mm x 75mm box (3x3)			C6401 .03	401.00	C6401 .16	483.00
2M Plate - for 75mm x 75mm box (3x3)			C6402 .03	436.00	C6402 .16	553.00
3M Plate - for 100mm x 75mm box (4x3)			C6403 .03	482.00	C6403 .16	599.00
4M Plate - for 135mm x 75mm box (5x3)			C6404 .03	512.00	C6404 .16	644.00
6M Plate - for 210mm x 75mm box (8x3)			C6406 .03	926.00	C6406 .16	1112.00
8M Plate - for 230/210 x 75mm box (9x3 or 8x3)			C6408 .03	1027.00	C6408 .16	1234.00
8M (V) Plate - for 135mm x 140mm box (5x5)			C6409 .03	1325.00	C6409 .16	1591.00
12M Plate - for 140mm x 210mm box (8x6)			C6412 .03	1583.00	C6412 .16	1902.00
14M Plate - for 140mm x 210mm box (8x6)			C6414 .03	1863.00	C6414 .16	2237.00
16M Plate - for 230x145mm box (10x6 or 9x6)			C6416 .03	2092.00	C6416 .16	2514.00
21M Plate - for 210mm x 210mm box (8x8)			C6421 .03	2403.00	C6421 .16	2885.00



C6401 .17 C6401 .26
C6401 .25



C6402 .17 C6402 .26
C6402 .25



C6403 .17 C6403 .26
C6403 .25

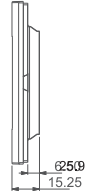

C6404 .17 C6404 .26
C6404 .25



C6406 .17 C6406 .26
C6406 .25

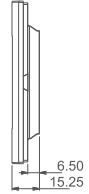

C6408 .17 C6408 .26
C6408 .25

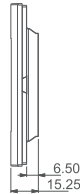

C6409 .17 C6409 .26
C6409 .25



C6412 .17 C6412 .26
C6412 .25

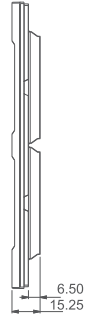

Images for 14M Plate, 16M Plate and 21M Plate are not shown here

CUBE Series

Flat'5 plates with frames Charcoal Black and Cocoa Brown

	Charcoal Black		Cocoa Brown	
	Cat no.	Price	Cat no.	Price
1M Plate - for 75mm x 75mm box (3x3)	C6401	.17 498.00	C6401	.25 498.00
2M Plate - for 75mm x 75mm box (3x3)	C6402	.17 573.00	C6402	.25 573.00
3M Plate - for 100mm x 75mm box (4x3)	C6403	.17 625.00	C6403	.25 625.00
4M Plate - for 135mm x 75mm box (5x3)	C6404	.17 671.00	C6404	.25 671.00
6M Plate - for 210mm x 75mm box (8x3)	C6406	.17 1154.00	C6406	.25 1154.00
8M Plate - for 230/210 x 75mm box (9x3 or 8x3)	C6408	.17 1252.00	C6408	.25 1252.00
8M (V) Plate - for 135mm x 140mm box (5x5)	C6409	.17 1677.00	C6409	.25 1677.00
12M Plate - for 140mm x 210mm box (8x6)	C6412	.17 1965.00	C6412	.25 1965.00
14M Plate - for 140mm x 210mm box (8x6)	C6414	.17 2280.00	C6414	.25 2280.00
16M Plate - for 230x145mm box (10x6 or 9x6)	C6416	.17 2659.00	C6416	.25 2659.00
21M Plate - for 210mm x 210mm box (8x8)	C6421	.17 3035.00	C6421	.25 3035.00

73

Flat'5 plates with frames Silver Dust

Description	Silver Dust	
	Cat no.	Price
1M Plate - for 75mm x 75mm box (3x3)	C6401	.26 498.00
2M Plate - for 75mm x 75mm box (3x3)	C6402	.26 573.00
3M Plate - for 100mm x 75mm box (4x3)	C6403	.26 625.00
4M Plate - for 135mm x 75mm box (5x3)	C6404	.26 671.00
6M Plate - for 210mm x 75mm box (8x3)	C6406	.26 1154.00
8M Plate - for 230/210 x 75mm box (9x3 or 8x3)	C6408	.26 1252.00
8M (V) Plate - for 135mm x 140mm box (5x5)	C6409	.26 1677.00
12M Plate - for 140mm x 210mm box (8x6)	C6412	.26 1965.00
14M Plate - for 140mm x 210mm box (8x6)	C6414	.26 2280.00
16M Plate - for 230x145mm box (10x6 or 9x6)	C6416	.26 2659.00
21M Plate - for 210mm x 210mm box (8x8)	C6421	.26 3035.00



CA304 .04
Solid Aluminum Plate - 4 Module
natural finish mounted with
modules C5706 .01 and C5110 .01

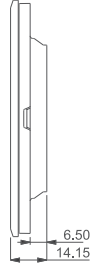

CA304 .05
Solid Aluminum Plate - 4 Module
black finish mounted with
C5706 .02, C5701 .02, C5726 .02

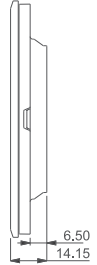

CA304 .14
Solid Aluminum Plate - 4 Module
Dark Bronze mounted with
modules C5110 .02 and C5721 .02

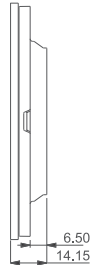

CUBE Series

Solid Aluminum Plates with frames Natural & Black

Description	Aluminum Natural		Aluminum Black	
	Cat no.	Price	Cat no.	Price
1M Plate - for 75mm x 75mm box (3x3)	CA301 .04	1761.00	CA301 .05	1761.00
2M Plate - for 75mm x 75mm box (3x3)	CA302 .04	1786.00	CA302 .05	1786.00
3M Plate - for 100mm x 75mm box (4x3)	CA303 .04	1894.00	CA303 .05	1894.00
4M Plate - for 135mm x 75mm box (5x3)	CA304 .04	2128.00	CA304 .05	2128.00
6M Plate - for 210mm x 75mm box (8x3)	CA306 .04	2330.00	CA306 .05	2330.00
8M Plate - for 230/210 x 75mm box (9x3 or 8x3)	CA308 .04	2523.00	CA308 .05	2523.00
8M (V) Plate - for 135mm x 140mm box (5x5)	CA309 .04	4592.00	CA309 .05	4592.00
12M Plate - for 140mm x 210mm box (8x6)	CA312 .04	5776.00	CA312 .05	5776.00
14M Plate - for 140mm x 210mm box (8x6)	CA314 .04	6283.00	CA314 .05	6283.00
16M Plate - for 230x145mm box (10x6 or 9x6)	CA316 .04	9400.00	CA316 .05	9400.00
21M Plate - for 210mm x 210mm box (8x8)	CA321 .04	12485.00	CA321 .05	12485.00

75

Solid Aluminum Plates with frames Dark Bronze

Description	Dark Bronze	
	Cat no.	Price
1M Plate - for 75mm x 75mm box (3x3)	CA301 .14	1936.00
2M Plate - for 75mm x 75mm box (3x3)	CA302 .14	1966.00
3M Plate - for 100mm x 75mm box (4x3)	CA303 .14	2084.00
4M Plate - for 135mm x 75mm box (5x3)	CA304 .14	2341.00
6M Plate - for 210mm x 75mm box (8x3)	CA306 .14	2563.00
8M Plate - for 230/210 x 75mm box (9x3 or 8x3)	CA308 .14	2778.00
8M (V) Plate - for 135mm x 140mm box (5x5)	CA309 .14	5051.00
12M Plate - for 140mm x 210mm box (8x6)	CA312 .14	6355.00
14M Plate - for 140mm x 210mm box (8x6)	CA314 .14	6877.00
16M Plate - for 230x145mm box (10x6 or 9x6)	CA316 .14	10342.00
21M Plate - for 210mm x 210mm box (8x8)	CA321 .14	13735.00

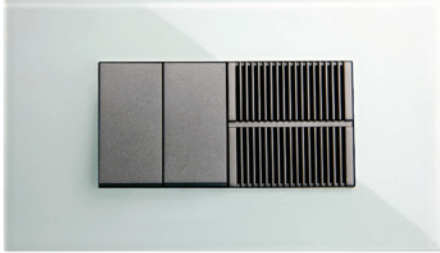

CG304 .08
Solid Glass Plate - 4 Module
ice white finish mounted with
modules C5110 .02 and C5706 .02

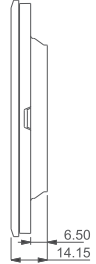

CG304 .09
Solid Glass Plate - 4 Module
metal gray finish mounted with
modules C5110 .01

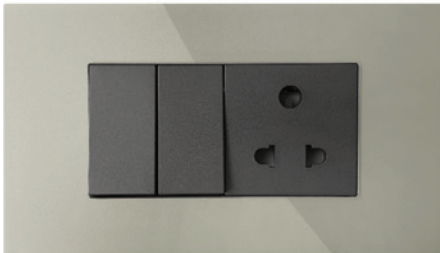
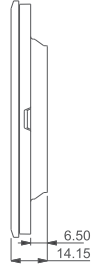

CG304 .18
Solid Glass Plate - 4 Module
Smoked Silver mounted with
modules C5110 .02 and C5212 .02

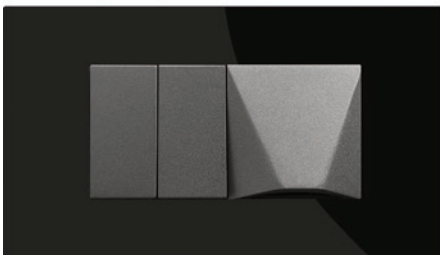
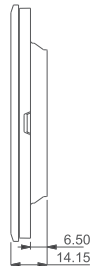

CG304 .19
Solid Glass Plate - 4 Module
Solid Black mounted with
modules C5110 .02 and C5721 .02

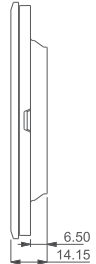

CUBE Series

Solid Glass Plates with frames Ice White & Metal Gray

Description	Ice White		Metal Gray	
	Cat no.	Price	Cat no.	Price
1M Plate - for 75mm x 75mm box (3x3)	CG301 .08	1260.00	CG301 .09	1260.00
2M Plate - for 75mm x 75mm box (3x3)	CG302 .08	1280.00	CG302 .09	1280.00
3M Plate - for 100mm x 75mm box (4x3)	CG303 .08	1356.00	CG303 .09	1356.00
4M Plate - for 135mm x 75mm box (5x3)	CG304 .08	1524.00	CG304 .09	1524.00
6M Plate - for 210mm x 75mm box (8x3)	CG306 .08	1668.00	CG306 .09	1668.00
8M Plate - for 230/210 x 75 mm x (9x3 or 8x3)	CG308 .08	1807.00	CG308 .09	1807.00
8M (V) Plate - for 135mm x 140mm box (5x5)	CG309 .08	2208.00	CG309 .09	2208.00
12M Plate - for 140mm x 210mm box (8x6)	CG312 .08	2809.00	CG312 .09	2809.00
14M Plate - for 140mm x 210mm box (8x6)	CG314 .08	3492.00	CG314 .09	3492.00
16M Plate - for 230x145mm box (10x6 or 9x6)	CG316 .08	4966.00	CG316 .09	4966.00
21M Plate - for 210mm x 210mm box (8x8)	CG321 .08	6437.00	CG321 .09	6437.00

77

Solid Glass Plates with frames Smoked Silver, Solid Black & Ultra White

Description	Smoked Silver		Solid Black		Ultra White	
	Cat no.	Price	Cat no.	Price	Cat no.	Price
1M Plate	CG301 .18	1260.00	CG301 .19	1260.00	CG301 .38	1722.00
2M Plate	CG302 .18	1280.00	CG302 .19	1280.00	CG302 .38	1773.00
3M Plate	CG303 .18	1356.00	CG303 .19	1356.00	CG303 .38	1853.00
4M Plate	CG304 .18	1524.00	CG304 .19	1524.00	CG304 .38	2082.00
6M Plate	CG306 .18	1668.00	CG306 .19	1668.00	CG306 .38	2286.00
8M Plate	CG308 .18	1807.00	CG308 .19	1807.00	CG308 .38	2485.00
8M (V) Plate	CG309 .18	2208.00	CG309 .19	2208.00	CG309 .38	3018.00
12M Plate	CG312 .18	2809.00	CG312 .19	2809.00	CG312 .38	3839.00
14M Plate	CG314 .18	3492.00	CG314 .19	3492.00	CG314 .38	4376.00
16M Plate	CG316 .18	4966.00	CG316 .19	4966.00	CG316 .38	6786.00
21M Plate	CG321 .18	6437.00	CG321 .19	6437.00	CG321 .38	8797.00



CM304 .10
Solid Marble Finish Plate - 4 Module
Sparkle White finish mounted with
modules C5715 .01 and C5721 .01

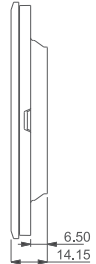

CM304 .11
Solid Marble Finish Plate - 4 Module
Terra Beige finish mounted with
modules C5110 .01 and C5900 .01

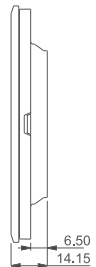

CM304 .12
Solid Marble Finish Plate - 4 Module
Salt White finish mounted with
modules C5739 .02 and C5723 .02

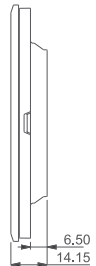

CM304 .13
Solid Marble Finish Plate - 4 Module
Onyx White finish mounted with
modules C5110 .02 and C5721 .02

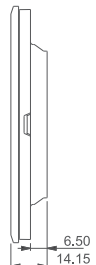

CUBE Series

Solid Marble Finish Plates with frames Sparkle White & Terra Beige

Description	Sparkle White		Terra Beige	
	Cat no.	Price	Cat no.	Price
1M Plate - for 75mm x 75mm box (3x3)	CM301 .10	1156.00	CM301 .11	1156.00
2M Plate - for 75mm x 75mm box (3x3)	CM302 .10	1174.00	CM302 .11	1174.00
3M Plate - for 100mm x 75mm box (4x3)	CM303 .10	1244.00	CM303 .11	1244.00
4M Plate - for 135mm x 75mm box (5x3)	CM304 .10	1398.00	CM304 .11	1398.00
6M Plate - for 210mm x 75mm box (8x3)	CM306 .10	1530.00	CM306 .11	1530.00
8M Plate - for 230/210 x 75mm box (9x3 or 8x3)	CM308 .10	1658.00	CM308 .11	1658.00
8M (V) Plate - for 135mm x 140mm box (5x5)	CM309 .10	2041.00	CM309 .11	2041.00
12M Plate - for 140mm x 210mm box (8x6)	CM312 .10	2633.00	CM312 .11	2633.00
14M Plate - for 140mm x 210mm box (8x6)	CM314 .10	3298.00	CM314 .11	3298.00
16M Plate - for 230x145mm box (10x6 or 9x6)	CM316 .10	4490.00	CM316 .11	4490.00
21M Plate - for 210mm x 210mm box (8x8)	CM321 .10	5682.00	CM321 .11	5682.00

79

Solid Marble Finish Plates with frames Salt White & Onyx White

Description	Salt White		Onyx White	
	Cat no.	Price	Cat no.	Price
1M Plate - for 75mm x 75mm box (3x3)	CM301 .12	1273.00	CM301 .13	1273.00
2M Plate - for 75mm x 75mm box (3x3)	CM302 .12	1292.00	CM302 .13	1292.00
3M Plate - for 100mm x 75mm box (4x3)	CM303 .12	1368.00	CM303 .13	1368.00
4M Plate - for 135mm x 75mm box (5x3)	CM304 .12	1537.00	CM304 .13	1537.00
6M Plate - for 210mm x 75mm box (8x3)	CM306 .12	1685.00	CM306 .13	1685.00
8M Plate - for 230/210 x 75mm box (9x3 or 8x3)	CM308 .12	1825.00	CM308 .13	1825.00
8M (V) Plate - for 135mm x 140mm box (5x5)	CM309 .12	2245.00	CM309 .13	2245.00
12M Plate - for 140mm x 210mm box (8x6)	CM312 .12	2897.00	CM312 .13	2897.00
14M Plate - for 140mm x 210mm box (8x6)	CM314 .12	3628.00	CM314 .13	3628.00
16M Plate - for 230x145mm box (10x6 or 9x6)	CM316 .12	4940.00	CM316 .13	4940.00
21M Plate - for 210mm x 210mm box (8x8)	CM321 .12	6251.00	CM321 .13	6251.00

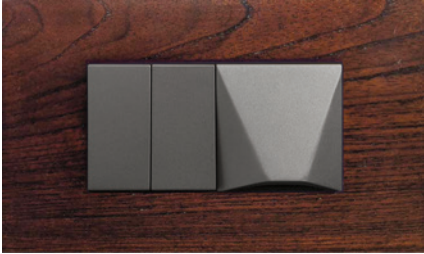

CW304 .06
Solid Wood Plate - 4 Module
dark mahogany mounted with
modules C5110 .02 and C5721 .02

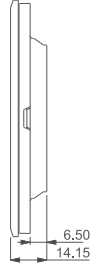

CW304 .07
Solid Wood Plate - 4 Module
natural pinewood mounted with
modules C5110 .01 and C5900 .01

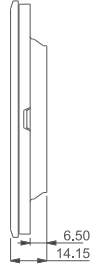

CW304 .29
Solid Wood Plate - 4 Module
walnut mounted with
modules C5110 .02 and C5212 .02

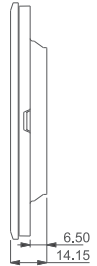

CUBE Series

Solid Wood Plates with frames Dark Mahogany & Natural Pinewood Polish

Description	Dark Mahogany		Pinewood	
	Cat no.	Price	Cat no.	Price
1M Plate - for 75mm x 75mm box (3x3)	CW301 .06	1256.00	CW301 .07	1256.00
2M Plate - for 75mm x 75mm box (3x3)	CW302 .06	1275.00	CW302 .07	1275.00
3M Plate - for 100mm x 75mm box (4x3)	CW303 .06	1352.00	CW303 .07	1352.00
4M Plate - for 135mm x 75mm box (5x3)	CW304 .06	1520.00	CW304 .07	1520.00
6M Plate - for 210mm x 75mm box (8x3)	CW306 .06	1664.00	CW306 .07	1664.00
8M Plate - for 230/210 x 75mm box (9x3 or 8x3)	CW308 .06	1801.00	CW308 .07	1801.00
8M (V) Plate - for 135mm x 140mm box (5x5)	CW309 .06	2876.00	CW309 .07	2876.00
12M Plate - for 140mm x 210mm box (8x6)	CW312 .06	3923.00	CW312 .07	3923.00
14M Plate - for 140mm x 210mm box (8x6)	CW314 .06	4576.00	CW314 .07	4576.00
16M Plate - for 230x145mm box (10x6 or 9x6)	CW316 .06	6319.00	CW316 .07	6319.00
21M Plate - for 210mm x 210mm box (8x8)	CW321 .06	8062.00	CW321 .07	8062.00

81

Solid Wood Plates with frames Walnut Polish

Description	Walnut	
	Cat no.	Price
1M Plate - for 75mm x 75mm box (3x3)	CW301 .29	1319.00
2M Plate - for 75mm x 75mm box (3x3)	CW302 .29	1339.00
3M Plate - for 100mm x 75mm box (4x3)	CW303 .29	1420.00
4M Plate - for 135mm x 75mm box (5x3)	CW304 .29	1595.00
6M Plate - for 210mm x 75mm box (8x3)	CW306 .29	1747.00
8M Plate - for 230/210 x 75mm box (9x3 or 8x3)	CW308 .29	1891.00
8M (V) Plate - for 135mm x 140mm box (5x5)	CW309 .29	3020.00
12M Plate - for 140mm x 210mm box (8x6)	CW312 .29	4119.00
14M Plate - for 140mm x 210mm box (8x6)	CW314 .29	4805.00
16M Plate - for 230x145mm box (10x6 or 9x6)	CW316 .29	6636.00
21M Plate - for 210mm x 210mm box (8x8)	CW321 .29	8465.00



D5212 .01



D5532 .01



D5531 .01



D5332 .01
D5732 .01



D5212 .02



D5532 .02



D5531 .02



D5332 .02
D5732 .02



D5212 .17



D5532 .17



D5531 .17



D5332 .17
D5732 .17

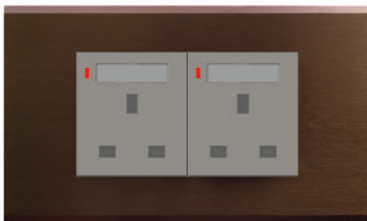

Integral Sockets can only be mounted on Special Flat'5 Plates suitable for mounting Integral Sockets. These plates are available in 2M & 4M sizes only. Colour options available in these plates are listed on the next page.

CUBE Series

Integral Sockets Frost White

Cat no.	Description	Price (Rs.)
D5212 .01	Integral Socket with Switch 6A 3+2 Pin [Round & Flat] Shuttered - 2M	647.00
D5532 .01	Integral Socket with Switch 13A International Multi Socket Shuttered - 2M	818.00
D5531 .01	Integral Socket with Switch 13A 3-Pin Flat Only Socket Shuttered - 2M	802.00
D5332 .01	Integral Socket with Switch 16A/6A 3-Pin Shuttered - 2 Module	828.00
D5732 .01	Integral Socket with Switch 25A/6A 3-Pin Shuttered - 2 Module	1112.00

Integral Sockets Quartz Gray

Cat no.	Description	Price (Rs.)
D5212 .02	Integral Socket with Switch 6A 3+2 Pin [Round & Flat] Shuttered - 2M	796.00
D5532 .02	Integral Socket with Switch 13A International Multi Socket Shuttered - 2M	1006.00
D5531 .02	Integral Socket with Switch 13A 3-Pin Flat Only Socket Shuttered - 2M	985.00
D5332 .02	Integral Socket with Switch 16A/6A 3-Pin Shuttered - 2 Module	1020.00
D5732 .02	Integral Socket with Switch 25A/6A 3-Pin Shuttered - 2 Module	1341.00

83

Integral Sockets Charcoal Black

Cat no.	Description	Price (Rs.)
D5212 .17	Integral Socket with Switch 6A 3+2 Pin [Round & Flat] Shuttered - 2M	859.00
D5532 .17	Integral Socket with Switch 13A International Multi Socket Shuttered - 2M	1086.00
D5531 .17	Integral Socket with Switch 13A 3-Pin Flat Only Socket Shuttered - 2M	1064.00
D5332 .17	Integral Socket with Switch 16A/6A 3-Pin Shuttered - 2 Module	1101.00
D5732 .17	Integral Socket with Switch 25A/6A 3-Pin Shuttered - 2 Module	1475.00

Flat'5 Plates Suitable for Integral Sockets

D6402 .01	2M Plate - for 93mm x 95mm box (3x3) - Frost White	275.00
D6404 .01	4M Plate - for 93mm x 158mm box (3x5) - Frost White	524.00
D6402 .02	2M Plate - for 93mm x 95mm box (3x3) - Quartz Gray	482.00
D6404 .02	4M Plate - for 93mm x 158mm box (3x5) - Quartz Gray	926.00

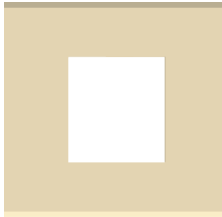

D6402 .01	DG302 .08
D6402 .02	DG302 .09
D6402 .03	DG302 .18
D6402 .16	DG302 .19
D6402 .17	DG302 .38
D6402 .25	DM302 .10
D6402 .26	DM302 .11
DA302 .04	DM302 .12
DA302 .05	DM302 .13
DA302 .14	DW302 .06

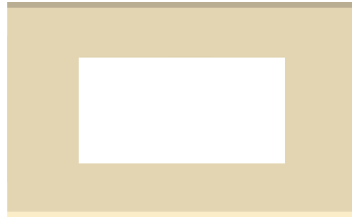

D6404 .01	DG304 .08
D6404 .02	DG304 .09
D6404 .03	DG304 .18
D6404 .16	DG304 .19
D6404 .17	DG304 .38
D6404 .25	DM304 .10
D6404 .26	DM304 .11
DA304 .04	DM304 .12
DA304 .05	Dm304 .13
DA304 .14	DW304 .06

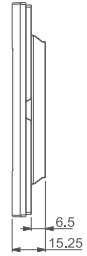

CUBE Series

contd...

D6402 .03	2M Plate - for 93mm x 95mm box (3x3) - Ice Silver	482.00
D6404 .03	4M Plate - for 93mm x 158mm box (3x5) - Ice Silver	926.00
D6402 .16	2M Plate - for 93mm x 95mm box (3x3) - Matt Gold	482.00
D6404 .16	4M Plate - for 93mm x 158mm box (3x5) - Matt Gold	926.00
D6402 .17	2M Plate - for 93mm x 95mm box (3x3) - Charcoal Black	482.00
D6404 .17	4M Plate - for 93mm x 158mm box (3x5) - Charcoal Black	926.00
D6402 .25	2M Plate - for 93mm x 95mm box (3x3) - Cocoa Brown	482.00
D6404 .25	4M Plate - for 93mm x 158mm box (3x5) - Cocoa Brown	926.00
D6402 .26	2M Plate - for 93mm x 95mm box (3x3) - Silver Dust	482.00
D6404 .26	4M Plate - for 93mm x 158mm box (3x5) - Silver Dust	926.00
DA302 .04	2M Plate - for 93mm x 95mm box (3x3) - Solid Aluminum Natural	1861.00
DA304 .04	4M Plate - for 93mm x 158mm box (3x5) - Solid Aluminum Natural	2290.00
DA302 .05	2M Plate - for 93mm x 95mm box (3x3) - Solid Aluminum Black	1861.00
DA304 .05	4M Plate - for 93mm x 158mm box (3x5) - Solid Aluminum Black	2290.00
DA302 .14	2M Plate - for 93mm x 95mm box (3x3) - Solid Aluminum Dark Bronze	1861.00
DA304 .14	4M Plate - for 93mm x 158mm box (3x5) - Solid Aluminum Dark Bronze	2290.00
DG302 .08	2M Plate - for 93mm x 95mm box (3x3) - Solid Glass Ice White	1298.00
DG304 .08	4M Plate - for 93mm x 158mm box (3x5) - Solid Glass Ice White	1598.00
DG302 .09	2M Plate - for 93mm x 95mm box (3x3) - Solid Glass Metal Gray	1298.00
DG304 .09	4M Plate - for 93mm x 158mm box (3x5) - Solid Glass Metal Gray	1598.00
DG302 .18	2M Plate - for 93mm x 95mm box (3x3) - Solid Glass Smoked Silver	1298.00
DG304 .18	4M Plate - for 93mm x 158mm box (3x5) - Solid Glass Smoked Silver	1598.00
DG302 .19	2M Plate - for 93mm x 95mm box (3x3) - Solid Glass Solid Black	1298.00
DG304 .19	4M Plate - for 93mm x 158mm box (3x5) - Solid Glass Solid Black	1598.00
DG302 .38	2M Plate - for 93mm x 95mm box (3x3) - Solid Glass Ultra White	1612.00
DG304 .38	4M Plate - for 93mm x 158mm box (3x5) - Solid Glass Ultra White	1984.00
DM302 .10	2M Plate - for 93mm x 95mm box (3x3) - Marble Finish Sparkle White	1244.00
DM304 .10	4M Plate - for 93mm x 158mm box (3x5) - Marble Finish Sparkle White	1529.00
DM302 .11	2M Plate - for 93mm x 95mm box (3x3) - Marble Finish Terra Beige	1244.00
DM304 .11	4M Plate - for 93mm x 158mm box (3x5) - Marble Finish Terra Beige	1529.00
DM302 .12	2M Plate - for 93mm x 95mm box (3x3) - Marble Finish Salt White	1244.00
DM304 .12	4M Plate - for 93mm x 158mm box (3x5) - Marble Finish Salt White	1529.00
DM302 .13	2M Plate - for 93mm x 95mm box (3x3) - Marble Finish Onix White	1244.00
DM304 .13	4M Plate - for 93mm x 158mm box (3x5) - Marble Finish Onix White	1529.00
DW302 .06	2M Plate - for 93mm x 95mm box (3x3) - Solid Wood Dark Mahogany	1353.00
DW304 .06	4M Plate - for 93mm x 158mm box (3x5) - Solid Wood Dark Mahogany	1664.00

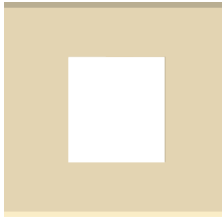

DW302 .07
DW302 .29



DW304 .07
DW304 .29

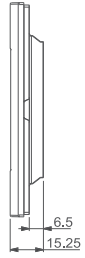

CUBE Series

contd...

DW302 .07	2M Plate - for 93mm x 95mm box (3x3) - Solid Natural Pinewood	1353.00
DW304 .07	4M Plate - for 93mm x 158mm box (3x5) - Solid Natural Pinewood	1664.00
DW302 .29	2M Plate - for 93mm x 95mm box (3x3) - Solid Wood Walnut	1421.00
DW304 .29	4M Plate - for 93mm x 158mm box (3x5) - Solid Wood Walnut	1747.00



C525A .01

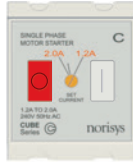

C525C .01

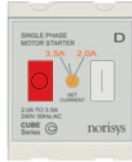

C525D .01



C525E .01

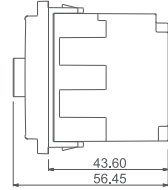

C525F .01



C525G .01



C525H .01



C525J .01



CTTSP06 .01



CTTSP10 .01



CTTSP16 .01



CTTSP20 .01



CTTSP25 .01



CTTSP32 .01

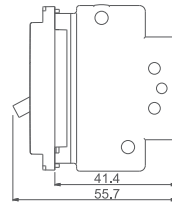

CTTDP06 .01
CTTDP10 .01



CTTDP16 .01
CTTDP20 .01



CTTDP25 .01
CTTDP32 .01



CLBDP32 .01
CLBDP50 .01

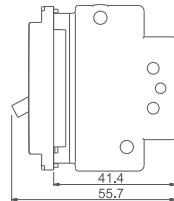

CUBE Series

Single Phase Motor Starters Frost White - for mounting with CUBE Series

Cat no.	Description		Price (Rs.)
C525A .01	Motor Starter 0.60 A - 1.00 A	1/8 HP Pump	858.00
C525B .01	Motor Starter 0.90 A - 1.50 A	1/4 HP Pump	858.00
C525C .01	Motor Starter 1.20 A - 2.00 A	1/3 HP Pump	858.00
C525D .01	Motor Starter 2.00 A - 3.50 A	1/2 HP Pump	858.00
C525E .01	Motor Starter 3.00 A - 5.00 A	3/4 HP Pump	858.00
C525F .01	Motor Starter 4.75 A - 7.50 A	1 Ton AC	858.00
C525G .01	Motor Starter 7.00 A - 11.50 A	1.5 Ton AC	858.00
C525H .01	Motor Starter 11.00 A - 18.00 A	2 Ton AC	891.00
C525J .01	Motor Starter 16.00 A - 25.00 A	2.5 Ton AC	975.00

Tiny MCB Frost White - for mounting with CUBE Series

CTTSP06 .01	Tiny MCB Single Pole 6A	398.00
CTTSP10 .01	Tiny MCB Single Pole 10A	398.00
CTTSP16 .01	Tiny MCB Single Pole 16A	398.00
CTTSP20 .01	Tiny MCB Single Pole 20A	398.00
CTTSP25 .01	Tiny MCB Single Pole 25A	398.00
CTTSP32 .01	Tiny MCB Single Pole 32A	398.00
CTTDP06 .01	Tiny MCB Double Pole 6A	993.00
CTTDP10 .01	Tiny MCB Double Pole 10A	993.00
CTTDP16 .01	Tiny MCB Double Pole 16A	993.00
CTTDP20 .01	Tiny MCB Double Pole 20A	993.00
CTTDP25 .01	Tiny MCB Double Pole 25A	993.00
CTTDP32 .01	Tiny MCB Double Pole 32A	993.00

Tiny Load Break Switch Frost White - for mounting with CUBE Series

CLBDP32 .01	Tiny Load Break Switch Double Pole 32A	860.00
CLBDP50 .01	Tiny Load Break Switch Double Pole 50A	954.00

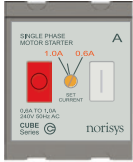

C525A .02

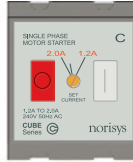

C525C .02

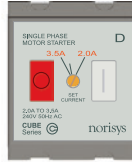

C525D .02

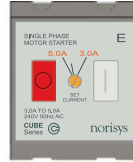

C525E .02

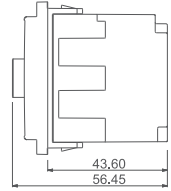

C525F .02



C525G .02



C525H .02

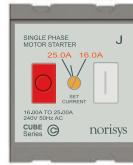

C525J .02

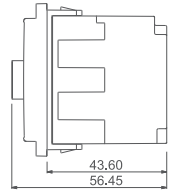

CTTSP06 .02



CTTSP10 .02



CTTSP16 .02



CTTSP20 .02



CTTSP25 .02



CTTSP32 .02

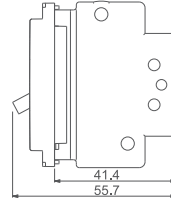

CTTDP06 .02
CTTDP10 .02



CTTDP16 .02
CTTDP20 .02



CTTDP25 .02
CTTDP32 .02



CLBDP32 .02
CLBDP50 .02

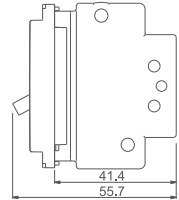

CUBE Series

Single Phase Motor Starters Quartz Gray - for mounting with CUBE Series

Cat no.	Description	Price (Rs.)
C525A .02	Motor Starter 0.60 A - 1.00 A 1/8 HP Pump	1065.00
C525B .02	Motor Starter 0.90 A - 1.50 A 1/4 HP Pump	1065.00
C525C .02	Motor Starter 1.20 A - 2.00 A 1/3 HP Pump	1065.00
C525D .02	Motor Starter 2.00 A - 3.50 A 1/2 HP Pump	1065.00
C525E .02	Motor Starter 3.00 A - 5.00 A 3/4 HP Pump	1065.00
C525F .02	Motor Starter 4.75 A - 7.50 A 1 Ton AC	1065.00
C525G .02	Motor Starter 7.00 A - 11.50 A 1.5 Ton AC	1065.00
C525H .02	Motor Starter 11.00 A - 18.00 A 2 Ton AC	1106.00
C525J .02	Motor Starter 16.00 A - 25.00 A 2.5 Ton AC	1208.00

Tiny MCB Quartz Gray - for mounting with CUBE Series

CTTSP06 .02	Tiny MCB Single Pole 6A	482.00
CTTSP10 .02	Tiny MCB Single Pole 10A	482.00
CTTSP16 .02	Tiny MCB Single Pole 16A	482.00
CTTSP20 .02	Tiny MCB Single Pole 20A	482.00
CTTSP25 .02	Tiny MCB Single Pole 25A	482.00
CTTSP32 .02	Tiny MCB Single Pole 32A	482.00
CTTDP06 .02	Tiny MCB Double Pole 6A	1212.00
CTTDP10 .02	Tiny MCB Double Pole 10A	1212.00
CTTDP16 .02	Tiny MCB Double Pole 16A	1212.00
CTTDP20 .02	Tiny MCB Double Pole 20A	1212.00
CTTDP25 .02	Tiny MCB Double Pole 25A	1212.00
CTTDP32 .02	Tiny MCB Double Pole 32A	1212.00

Tiny Load Break Switch Quartz Gray - for mounting with CUBE Series

CLBDP32 .02	Tiny Load Break Switch Double Pole 32A	1068.00
CLBDP50 .02	Tiny Load Break Switch Double Pole 50A	1183.00

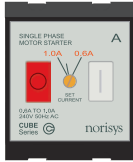

C525A .17

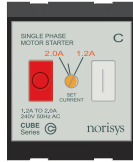

C525C .17

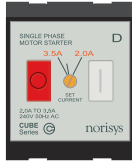

C525D .17

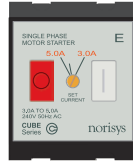

C525E .17

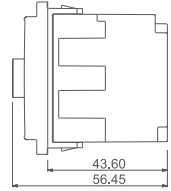

C525F .17



C525G .17



C525H .17



C525J .17

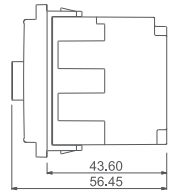

CTTSP06 .17



CTTSP10 .17



CTTSP16 .17



CTTSP20 .17



CTTSP25 .17



CTTSP32 .17

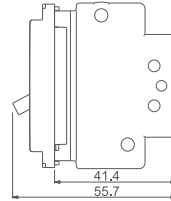

CTTDP06.17
CTTDP10.17



CTTDP16.17
CTTDP20.17



CTTDP25.17
CTTDP32.17

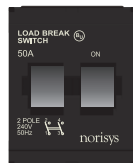

CLBDBP32.17
CLBDBP50.17

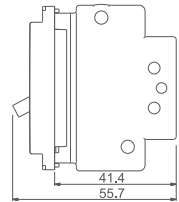

CUBE Series

Single Phase Motor Starters Charcoal Black - for mounting with CUBE Series

Cat no.	Description	Price (Rs.)
C525A .17	Motor Starter 0.60 A - 1.00 A 1/8 HP Pump	1161.00
C525B .17	Motor Starter 0.90 A - 1.50 A 1/4 HP Pump	1161.00
C525C .17	Motor Starter 1.20 A - 2.00 A 1/3 HP Pump	1161.00
C525D .17	Motor Starter 2.00 A - 3.50 A 1/2 HP Pump	1161.00
C525E .17	Motor Starter 3.00 A - 5.00 A 3/4 HP Pump	1161.00
C525F .17	Motor Starter 4.75 A - 7.50 A 1 Ton AC	1161.00
C525G .17	Motor Starter 7.00 A - 11.50 A 1.5 Ton AC	1161.00
C525H .17	Motor Starter 11.00 A - 18.00 A 2 Ton AC	1206.00
C525J .17	Motor Starter 16.00 A - 25.00 A 2.5 Ton AC	1318.00

Tiny MCB Charcoal Black - for mounting with CUBE Series

CTTSP06 .17	Tiny MCB Single Pole 6A	529.00
CTTSP10 .17	Tiny MCB Single Pole 10A	529.00
CTTSP16 .17	Tiny MCB Single Pole 16A	529.00
CTTSP20 .17	Tiny MCB Single Pole 20A	529.00
CTTSP25 .17	Tiny MCB Single Pole 25A	529.00
CTTSP32 .17	Tiny MCB Single Pole 32A	529.00
CTTDP06 .17	Tiny MCB Double Pole 6A	1321.00
CTTDP10 .17	Tiny MCB Double Pole 10A	1321.00
CTTDP16 .17	Tiny MCB Double Pole 16A	1321.00
CTTDP20 .17	Tiny MCB Double Pole 20A	1321.00
CTTDP25 .17	Tiny MCB Double Pole 25A	1321.00
CTTDP32 .17	Tiny MCB Double Pole 32A	1321.00

Tiny Load Break Switch Charcoal Black - for mounting with CUBE Series

CLBDP32 .17	Tiny Load Break Switch Double Pole 32A	1164.00
CLBDP50 .17	Tiny Load Break Switch Double Pole 50A	1290.00



S7110 .01
S7130 .01



S7210 .01
S7230 .01



S7111 .01
S7131 .01
S7731 .01



S7211 .01
S7231 .01



S7310 .01



S7311 .01

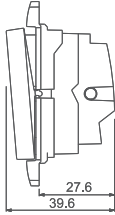

S7340 .01



S7341 .01



S7180 .01



S7191 .01
S7171 .01

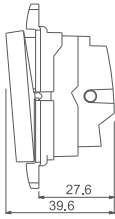

S8110 .01



S8210 .01



S8130 .01
S8730 .01



S8230 .01



S8310 .01



S8311 .01

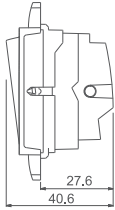

S8111 .01



S8211 .01



S8131 .01
S8731 .01



S8231 .01

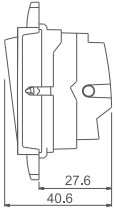

SQUARE Series

Switches Frost White

Cat no.	Description	Price (Rs.)
S7110 .01	Switch 6A One-way (Collarless Style) - 1 Module	104.00
S7111 .01	Switch 6A One-way with indicator (Collarless Style) - 1 Module	212.00
S7210 .01	Switch 6A Two-way (Collarless Style) - 1 Module	191.00
S7211 .01	Switch 6A Two-way with indicator (Collarless Style) - 1 Module	275.00
S7130 .01	Switch 16A One-way (Collarless Style) - 1 Module	227.00
S7131 .01	Switch 16A One-way with indicator (Collarless Style) - 1 Module	265.00
S7230 .01	Switch 16A Two-way (Collarless Style) - 1 Module	244.00
S7231 .01	Switch 16A Two-way with indicator (Collarless Style) - 1 Module	317.00
S7731 .01	Switch 25A One-way with indicator (Collarless Style) - 1 Module	383.00
S7310 .01	Switch 6A - Bell (Collarless Style) - 1 Module	197.00
S7311 .01	Switch 6A - Bell with indicator (Collarless Style) - 1 Module	250.00
S7340 .01	Palm Bell Switch 6A (Collarless Style) - 2 Module	251.00
S7341 .01	Palm Bell Switch 6A with indicator (Collarless Style) - 2 Module	282.00
S7180 .01	Palm Switch 6A One-way Double Pole (Collarless Style) - 2 Module	340.00
S7280 .01	Palm Switch 6A Two-way Double Pole (Collarless Style) - 2 Module	369.00
S7191 .01	Palm Switch 16A One-way DP with indicator (Collarless) - 2 Module	480.00
S7291 .01	Palm Switch 16A Two-way DP with indicator (Collarless) - 2 Module	566.00
S7171 .01	Palm Switch 25A One-way DP with indicator (Collarless) - 2 Module	571.00
S8110 .01	Switch 6A One-way (Collar Style) - 1 Module	91.00
S8111 .01	Switch 6A One-way with indicator (Collar Style) - 1 Module	201.00
S8210 .01	Switch 6A Two-way (Collar Style) - 1 Module	188.00
S8211 .01	Switch 6A Two-way with indicator (Collar Style) - 1 Module	255.00
S8130 .01	Switch 16A One-way (Collar Style) - 1 Module	229.00
S8131 .01	Switch 16A One-way with indicator (Collar Style) - 1 Module	254.00
S8230 .01	Switch 16A Two-way (Collar Style) - 1 Module	246.00
S8231 .01	Switch 16A Two-way with indicator (Collar Style) - 1 Module	343.00
S8730 .01	Switch 25A One-way (Collar Style) - 1 Module	298.00
S8731 .01	Switch 25A One-way with indicator (Collar Style) - 1 Module	356.00
S8310 .01	Switch 6A - Bell (Collar Style) - 1 Module	188.00
S8311 .01	Switch 6A - Bell with indicator (Collar Style) - 1 Module	236.00



S7213 .01



S7332 .01
S7732 .01

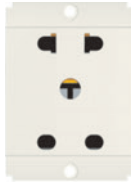

S7412 .01



S7532 .01
S7531 .01

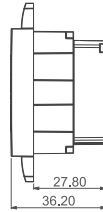

S1010 .01

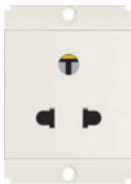

S7212 .01

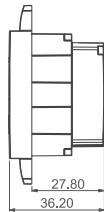

S7900 .01
S7910 .01
S7912 .01



S7901 .01
S7911 .01



S7913 .01



S7904 .01

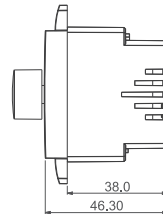

S7902 .01
S7903 .01



S7905 .01
S7908 .01

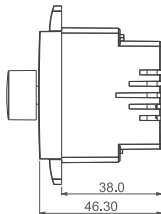

SQUARE Series

Sockets Frost White

Cat no.	Description	Price (Rs.)
S7213 .01	Socket 6A 3-Pin-only Shuttered - 2 Module (As per Indian Standard)	251.00
S7332 .01	Socket 16A/6A 3-Pin Shuttered - 2 Module (As per Indian Standard)	356.00
S7212 .01	Socket 6A 3+2 Pin [Round & Flat] Shuttered - 2 Module *	268.00
S7412 .01	Socket 6A 3+2 Pin And 2 pin Shuttered - 2 Module *	378.00
S1010 .01	Socket 6A 2 Pin [Round & Flat] - 1 Module *	179.00
S7532 .01	Socket 13A International Multi-Socket Shuttered - 2 Module *	356.00
S7531 .01	Socket 13A 3-Pin Flat Socket Shuttered - 2 Module *	345.00
S7732 .01	Socket 25A/6A 3-Pin Shuttered - 2 Module *	404.00

Fan Regulators & Dimmers Frost White

S7900 .01	Fan Regulator Step Type with Bar Knob for 80W fan - 2 Module	959.00
S7901 .01	Fan Regulator Step Type with Round Knob for 80W fan - 2 Module	912.00
S7910 .01	Fan Regulator Step Type with Bar Knob for 120W fan - 2 Module	1054.00
S7911 .01	Fan Regulator Step Type with Round Knob for 120W fan - 2 Module	1004.00
S7912 .01	Fan Regulator 8-Step Type with Bar Knob for 120W fan - 2 Module	1096.00
S7913 .01	Fan Regulator 8-Step Type with Round Knob for 120W fan - 2 Module	1046.00
S7902 .01	Dimmer 500 Watts - 2 Module	758.00
S7903 .01	Dimmer 1000 Watts - 2 Module	1040.00
S7904 .01	Fan Regulator Single Module for 80W Fan - Step Type - 1 Module	534.00
S7905 .01	Dimmer 500 Watts - 1 Module	569.00
S7908 .01	Dimmer for LED Lights (3 wire system) - 1 Module	566.00

97

* Only for export outside India



S7797 .01



S7800 .01
S7101 .01



S7820 .01



S7600 .01



S7802 .01
S7100 .01



S7725 .01
S7736 .01

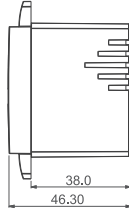

S7836 .01



S7936 .01



S7937 .01



S7729 .01

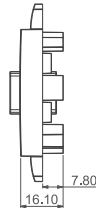

SQUARE Series

Communique' Frost White

Cat no.	Description	Price (Rs.)
S7797 .01	Coaxial T.V Socket - 1 Module	187.00
S7800 .01	Telephone Socket RJ-11 Double Line Shuttered - 1 Module	194.00
S7820 .01	Twin Telephone Socket RJ-11 - 1 Module	257.00
S7802 .01	Information Socket 6e - UTP Shuttered - 1 Module	655.00
S7100 .01	Information Socket 6a - UTP Shuttered - 1 Module	1126.00
S7725 .01	USB Extension Socket - 1 Module	516.00
S7736 .01	USB Charger Socket Outlet A Type- 2,1 Amps - 1 Module	2289.00
S7836 .01	USB Charger Socket Outlet C Type - 2,1 Amps - 1 Module	2531.00
S7936 .01	USB Charger Socket Outlet A+C Type - 2,1 Amps - 1 Module	2759.00
S7937 .01	USB Charger Socket Outlet C+C Type - 3,1 Amps - 1 Module	3148.00
S7729 .01	Computer Monitor Output Socket - 1 Module	335.00
S7101 .01	Fitment for RJ-45 Computer Socket Shuttered - 1 Module	208.00
S7600 .01	Indicator Light - 1 Module	119.00



S7232 .01



S7233 .01



S8232 .01



S8233 .01

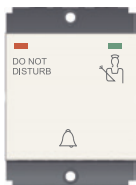

S7262 .01

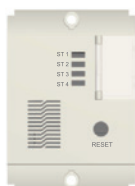
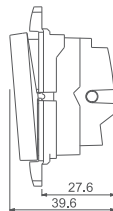

S7711 .01



S7450 .01



S7460 .01



S7500 .01

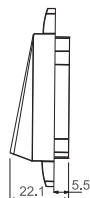

S7706 .01
S7707 .01
S7709 .01



S7721 .01



S7700 .01



S7798 .01

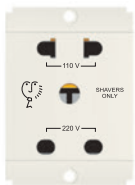
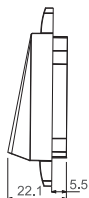

S7723 .01



S7719 .01



S7720 .01

SQUARE Series

Hospitality Modules Frost White

Cat no.	Description	Price (Rs.)
S7232 .01	"Do Not Disturb" Switch with indicator (Collarless Style) - 1 Module	363.00
S7233 .01	"Clean My Room" Switch with indicator (Collarless Style) - 1 Module	363.00
S8232 .01	"Do Not Disturb" Switch with indicator (Collar Style) - 1 Module	348.00
S8233 .01	"Clean My Room" Switch with indicator (Collar Style) - 1 Module	348.00
S7262 .01	Bell Switch with "Do Not Disturb" and "Clean My Room" indicator - 2M	588.00
S7711 .01	Call Bell Station with Register and Provision for External Buzzer - 2M	1391.00
S7719 .01	25A Key Fob Switch Double Pole with indicator - 2 Module	1132.00
S7720 .01	Key Fob - customized	201.00
S7723 .01	Shaver Socket 220V / 110V with transformer - 2 module	940.00
S7450 .01	Push Button Station Start - Stop (Collorless Style) - 2 Module	505.00
S7460 .01	Push Button Station Open - Close (Collorless Style) - 2 Module	562.00

101

Acoustic and Optical Signaling Frost White

S7706 .01	Speaker for audio music circuit - 2 Module	1134.00
S7707 .01	Electronic Bell - 2 Module	642.00
S7709 .01	Electronic Buzzer - 2 Module	575.00
S7721 .01	Step Marker Lamp / Night Lamp - 2 Module	593.00
S7798 .01	Audio Port / Jack 3.5mm - 1 Module	392.00

Support Modules Frost White

S7500 .01	Cord Outlet - 1 Module	128.00
S7700 .01	Blanking Plate - 1 Module	45.00



S7110 .23



S7210 .23



S7111 .23



S7211 .23



S7310 .23



S7311 .23

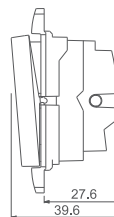

S7130 .23



S7230 .23



S7131 .23



S7731 .23



S7231 .23

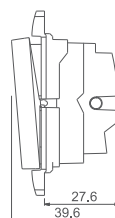

S7340 .23

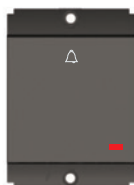

S7341 .23



S7180 .23



S7191 .23

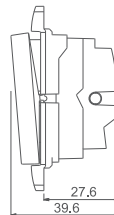

S7171 .23

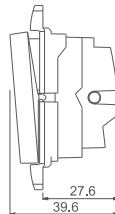

SQUARE Series

Switches Graphite Gray

Cat no.	Description	Price (Rs.)
S7110 .23	Switch 6A One-way (Collarless Style) - 1 Module	126.00
S7111 .23	Switch 6A One-way with indicator (Collarless Style) - 1 Module	264.00
S7210 .23	Switch 6A Two-way (Collarless Style) - 1 Module	235.00
S7211 .23	Switch 6A Two-way with indicator (Collarless Style) - 1 Module	339.00
S7130 .23	Switch 16A One-way (Collarless Style) - 1 Module	281.00
S7131 .23	Switch 16A One-way with indicator (Collarless Style) - 1 Module	328.00
S7230 .23	Switch 16A Two-way (Collarless Style) - 1 Module	302.00
S7231 .23	Switch 16A Two-way with indicator (Collarless Style) - 1 Module	392.00
S7731 .23	Switch 25A One-way with indicator (Collarless Style) - 1 Module	473.00
S7310 .23	Switch 6A - Bell (Collarless Style) - 1 Module	243.00
S7311 .23	Switch 6A - Bell with indicator (Collarless Style) - 1 Module	309.00
S7340 .23	Palm Bell Switch 6A (Collarless Style) - 2 Module	302.00
S7341 .23	Palm Bell Switch 6A with indicator (Collarless Style) - 2 Module	339.00
S7180 .23	Palm Switch 6A One-way Double Pole (Collarless Style) - 2 Module	410.00
S7280 .23	Palm Switch 6A Two-way Double Pole (Collarless Style) - 2 Module	440.00
S7191 .23	Palm Switch 16A One-way DP with indicator (Collarless) - 2 Module	578.00
S7291 .23	Palm Switch 16A Two-way DP with indicator (Collarless) - 2 Module	679.00
S7171 .23	Palm Switch 25A One-way DP with indicator (Collarless) - 2 Module	686.00



S7213 .23



S7332 .23
S7732 .23



S7412 .23



S7532 .23
S7531 .23

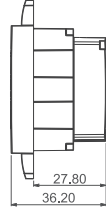

S1010 .23



S7212 .23

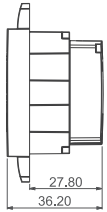

S7900 .23
S7910 .23
S7912 .23



S7901 .23
S7911 .23



S7913 .23



S7904 .23

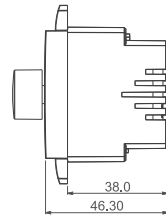

S7902 .23
S7903 .23



S7905 .23
S7908 .23

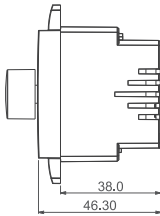

SQUARE Series

Sockets Graphite Gray

Cat no.	Description	Price (Rs.)
S7213 .23	Socket 6A 3-Pin-only Shuttered - 2 Module (As per Indian Standard)	303.00
S7332 .23	Socket 16A/6A 3-Pin Shuttered - 2 Module (As per Indian Standard)	433.00
S7212 .23	Socket 6A 3+2 Pin [Round & Flat] Shuttered - 2 Module *	321.00
S7412 .23	Socket 6A 3+2 Pin And 2 pin Shuttered - 2 Module *	454.00
S1010 .23	Socket 6A 2 Pin [Round & Flat] - 1 Module *	214.00
S7532 .23	Socket 13A International Multi-Socket Shuttered - 2 Module *	433.00
S7531 .23	Socket 13A 3-Pin Flat Socket Shuttered - 2 Module *	416.00
S7732 .23	Socket 25A/6A 3-Pin Shuttered - 2 Module *	486.00

Fan Regulators & Dimmers Graphite Gray

S7900 .23	Fan Regulator Step Type with Bar Knob for 80W fan - 2 Module	1151.00
S7901 .23	Fan Regulator Step Type with Round Knob for 80W fan - 2 Module	1096.00
S7910 .23	Fan Regulator Step Type with Bar Knob for 120W fan - 2 Module	1266.00
S7911 .23	Fan Regulator Step Type with Round Knob for 120W fan - 2 Module	1205.00
S7912 .23	Fan Regulator 8-Step Type with Bar Knob for 120W fan - 2 Module	1317.00
S7913 .23	Fan Regulator 8-Step Type with Round Knob for 120W fan - 2 Module	1256.00
S7902 .23	Dimmer 500 Watts - 2 Module	910.00
S7903 .23	Dimmer 1000 Watts - 2 Module	1248.00
S7904 .23	Fan Regulator Single Module for 80W Fan - Step Type - 1 Module	643.00
S7905 .23	Dimmer 500 Watts - 1 Module	685.00
S7908 .23	Dimmer for LED Lights (3 wire system) - 1 Module	679.00

105

* Only for export outside India



S7797 .23



S7800 .23
S7101 .23



S7820 .23



S7600 .23



S7802 .23
S7100 .23



S7725 .23
S7736 .23

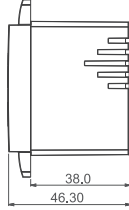

S7836 .23



S7936 .23



S7937 .23



S7729 .23

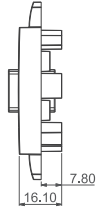

SQUARE Series

Communique' Graphite Gray

Cat no.	Description	Price (Rs.)
S7797 .23	Coaxial T.V Socket - 1 Module	225.00
S7800 .23	Telephone Socket RJ-11 Double Line Shuttered - 1 Module	233.00
S7820 .23	Twin Telephone Socket RJ-11 - 1 Module	309.00
S7802 .23	Information Socket 6e - UTP Shuttered - 1 Module	788.00
S7100 .23	Information Socket 6a - UTP Shuttered - 1 Module	1362.00
S7725 .23	USB Extension Socket - 1 Module	618.00
S7736 .23	USB Charger Socket Outlet A Type - 2,1 Amps - 1 Module	2722.00
S7836 .23	USB Charger Socket Outlet C Type - 2,1 Amps - 1 Module	3008.00
S7936 .23	USB Charger Socket Outlet A+C Type - 2,1 Amps - 1 Module	3280.00
S7937 .23	USB Charger Socket Outlet C+C Type - 3,1 Amps - 1 Module	3746.00
S7729 .23	Computer Monitor Output Socket - 1 Module	402.00
S7101 .23	Fitment for RJ-45 Computer Socket Shuttered - 1 Module	250.00
S7600 .23	Indicator Light - 1 Module	143.00



S7232 .23



S7233 .23



S7706 .23

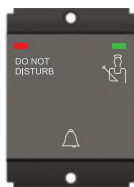

S7262 .23

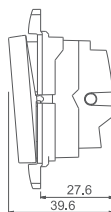

S7711 .23



S7450 .23



S7460 .23



S7500 .23

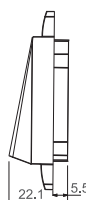

S7707 .23
S7709 .23



S7721 .23



S7700 .23



S7798 .23

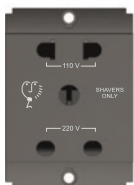
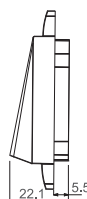

S7723 .23



S7719 .23



S7720 .23

SQUARE Series

Hospitality Modules Graphite Gray

Cat no.	Description	Price (Rs.)
S7232 .23	"Do Not Disturb" Switch with indicator (Collarless Style) - 1 Module	436.00
S7233 .23	"Clean My Room" Switch with indicator (Collarless Style) - 1 Module	436.00
S7262 .23	Bell Switch with "Do Not Disturb" and "Clean My Room" indicator - 2M	707.00
S7711 .23	Call Bell Station with Register and Provision for External Buzzer - 2M	1670.00
S7719 .23	25A Key Fob Switch Double Pole with indicator - 2 Module	1359.00
S7720 .23	Key Fob - customized	240.00
S7723 .23	Shaver Socket 220V / 110V with transformer - 2 module	1128.00
S7450 .23	Push Button Station Start - Stop (Collarless Style) - 2 module	606.00
S7460 .23	Push Button Station Open - Close (Collarless Style) - 2 module	675.00

Acoustic and Optical Signaling Graphite Gray

S7706 .23	Speaker for audio music circuit - 2 Module	1360.00
S7707 .23	Electronic Bell - 2 Module	772.00
S7709 .23	Electronic Buzzer - 2 Module	691.00
S7721 .23	Step Marker Lamp / Night Lamp - 2 Module	712.00
S7798 .23	Audio Port / Jack 3.5mm - 1 Module	471.00

109

Support Modules Graphite Gray

S7500 .23	Cord Outlet - 1 Module	153.00
S7700 .23	Blanking Plate - 1 Module	51.00



S7601 .01 S7601 .25
S7601 .03 S7601 .27
S7601 .23

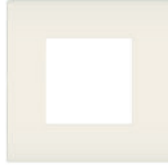

S7602 .01 S7602 .25
S7602 .03 S7602 .27
S7602 .23



S7633 .01 S7633 .25
S7633 .03 S7633 .27
S7633 .23

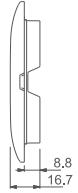

S7631 .01 S7631 .25
S7631 .03 S7631 .27
S7631 .23

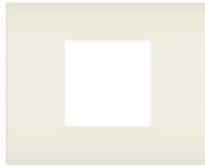

S7632 .01 S7632 .25
S7632 .03 S7632 .27
S7632 .23



S7604 .01 S7604 .25
S7604 .03 S7604 .27
S7604 .23

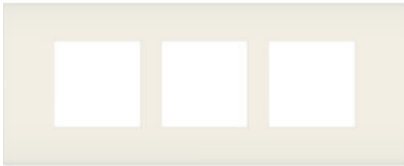
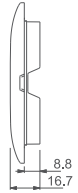

S7606 .01 S7606 .25
S7606 .03 S7606 .27
S7606 .23



S7608 .01 S7608 .25
S7608 .03 S7608 .27
S7608 .23



S7609 .01 S7609 .25
S7609 .03 S7609 .27
S7609 .23

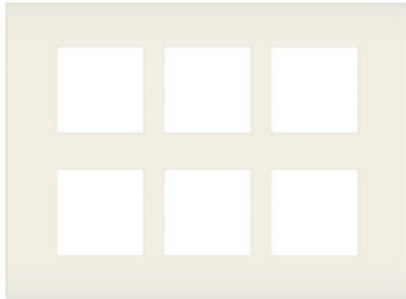

S7612 .01 S7612 .25
S7612 .03 S7612 .27
S7612 .23

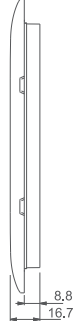

SQUARE Series

Smart Plates with frames Frost White and Wood Finish

Description	Frost White		Wood Finish	
	Cat no.	Price (Rs.)	Cat no.	Price (Rs.)
1M Plate - for 75mm x 75mm box (3x3)	S7601	.01 145.00	S7601	.27 474.00
2M Plate - for 75mm x 75mm box (3x3)	S7602	.01 145.00	S7602	.27 474.00
3M Plate - for 100mm x 75mm box (4x3)	S7633	.01 164.00	S7633	.27 536.00
1M Plate - for 100mm x 75mm box (4x3)	S7631	.01 164.00	S7631	.27 536.00
2M Plate - for 100mm x 75mm box (4x3)	S7632	.01 164.00	S7632	.27 536.00
4M Plate - for 135mm x 75mm box (5x3)	S7604	.01 180.00	S7604	.27 589.00
6M Plate - for 210mm x 75mm box (8x3)	S7606	.01 300.00	S7606	.27 985.00
8M Plate - for 230mm x 75mm box (9x3)	S7608	.01 357.00	S7608	.27 1171.00
8M(V) Plate - for 135mm x 140mm box (5x5)	S7609	.01 418.00	S7609	.27 1372.00
12M Plate - for 140mm x 210mm box (8x6)	S7612	.01 495.00	S7612	.27 1625.00
18M Plate - for 210mm x 210mm box (8x8)	S7618	.01 648.00	S7618	.27 2128.00

111

Smart Plates with frames Graphite Gray, Cocoa Brown and Ice Silver

Description	Graphite Gray		Cocoa Brown		Ice Silver	
	Cat no.	Price (Rs.)	Cat no.	Price (Rs.)	Cat no.	Price (Rs.)
1M Plate	S7601	.23 206.00	S7601	.25 209.00	S7601	.03 209.00
2M Plate	S7602	.23 206.00	S7602	.25 209.00	S7602	.03 209.00
3M Plate	S7633	.23 232.00	S7633	.25 235.00	S7633	.03 235.00
1M Plate	S7631	.23 232.00	S7631	.25 235.00	S7631	.03 235.00
2M Plate	S7632	.23 232.00	S7632	.25 235.00	S7632	.03 235.00
4M Plate	S7604	.23 253.00	S7604	.25 257.00	S7604	.03 257.00
6M Plate	S7606	.23 423.00	S7606	.25 429.00	S7606	.03 429.00
8M Plate	S7608	.23 504.00	S7608	.25 512.00	S7608	.03 512.00
8M(V) Plate	S7609	.23 590.00	S7609	.25 601.00	S7609	.03 601.00
12M Plate	S7612	.23 699.00	S7612	.25 712.00	S7612	.03 712.00
18M Plate	S7618	.23 914.00	S7618	.25 931.00	S7618	.03 931.00



S725A .01



S725B .01

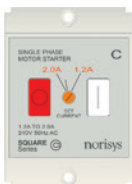

S725C .01



S725D .01

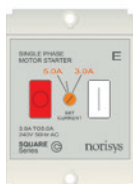

S725E .01



S725F .01



S725G .01



S725H .01

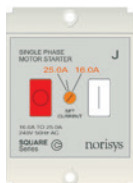

S725J .01



SQUARE Series

Single Phase Motor Starters Screw-mounting type - Frost White

Cat no.	Description	Price (Rs.)
S725A .01	Motor Starter 0.60 A - 1.00 A 1/8 HP Pump	744.00
S725B .01	Motor Starter 0.90 A - 1.50 A 1/4 HP Pump	744.00
S725C .01	Motor Starter 1.20 A - 2.00 A 1/3 HP Pump	744.00
S725D .01	Motor Starter 2.00 A - 3.50 A 1/2 HP Pump	744.00
S725E .01	Motor Starter 3.00 A - 5.00 A 3/4 HP Pump	744.00
S725F .01	Motor Starter 4.75 A - 7.50 A 1 Ton AC	744.00
S725G .01	Motor Starter 7.00 A - 11.50 A 1.5 Ton AC	744.00
S725H .01	Motor Starter 11.00 A - 18.00 A 2 Ton AC	776.00
S725J .01	Motor Starter 16.00 A - 25.00 A 2.5 Ton AC	844.00



STTSP06 .01



STTSP10 .01



STTSP16 .01



STTSP20 .01



STTSP25 .01



STTSP32 .01

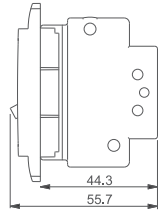

STTDP06 .01



STTDP10 .01



STTDP16 .01



STTDP20 .01

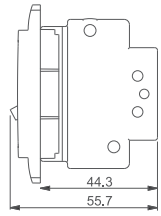

STTDP25 .01



STTDP32 .01



SLBDP32 .01



SLBDP50 .01

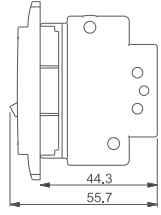

SQUARE Series

Tiny MCBs - Screw Mounting Type Frost White

Cat no.	Description	Price (Rs.)
STTSP06 .01	Tiny MCB Single Pole 6A	372.00
STTSP10 .01	Tiny MCB Single Pole 10A	372.00
STTSP16 .01	Tiny MCB Single Pole 16A	372.00
STTSP20 .01	Tiny MCB Single Pole 20A	372.00
STTSP25 .01	Tiny MCB Single Pole 25A	372.00
STTSP32 .01	Tiny MCB Single Pole 32A	372.00
STTDP06 .01	Tiny MCB Double Pole 6A	925.00
STTDP10 .01	Tiny MCB Double Pole 10A	925.00
STTDP16 .01	Tiny MCB Double Pole 16A	925.00
STTDP20 .01	Tiny MCB Double Pole 20A	925.00
STTDP25 .01	Tiny MCB Double Pole 25A	925.00
STTDP32 .01	Tiny MCB Double Pole 32A	925.00

115

Tiny Load Break Switch - Screw Mounting Type Frost White

SLBDP32 .01	Tiny Load Break Switch Double Pole 32A	790.00
SLBDP50 .01	Tiny Load Break Switch Double Pole 50A	864.00

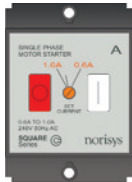

S725A .23



S725B .23



S725C .23



S725D .23

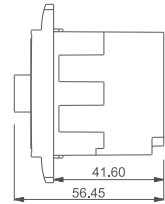

S725E .23



S725F .23



S725G .23



S725H .23



S725J .23

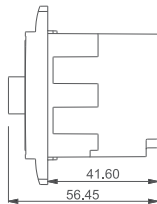

SQUARE Series

Single Phase Motor Starters Screw-mounting type - Graphite Gray

Cat no.	Description	Price (Rs.)
S725A .23	Motor Starter 0.60 A - 1.00 A 1/8 HP Pump	902.00
S725B .23	Motor Starter 0.90 A - 1.50 A 1/4 HP Pump	902.00
S725C .23	Motor Starter 1.20 A - 2.00 A 1/3 HP Pump	902.00
S725D .23	Motor Starter 2.00 A - 3.50 A 1/2 HP Pump	902.00
S725E .23	Motor Starter 3.00 A - 5.00 A 3/4 HP Pump	902.00
S725F .23	Motor Starter 4.75 A - 7.50 A 1 Ton AC	902.00
S725G .23	Motor Starter 7.00 A - 11.50 A 1.5 Ton AC	902.00
S725H .23	Motor Starter 11.00 A - 18.00 A 2 Ton AC	938.00
S725J .23	Motor Starter 16.00 A - 25.00 A 2.5 Ton AC	1021.00



STTSP06 .23



STTSP10 .23



STTSP16 .23



STTSP20 .23



STTSP25 .23



STTSP32 .23

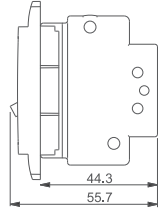

STTDP06 .23



STTDP10 .23



STTDP16 .23



STTDP20 .23

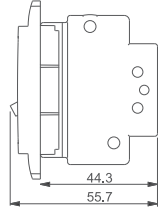

STTDP25 .23



STTDP32 .23

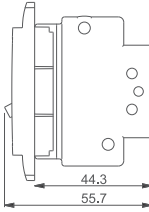

SLBDP32 .23



SLBDP50 .23

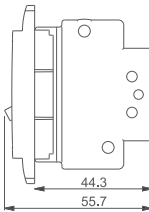

SQUARE Series

Tiny MCBs - Screw Mounting Type Graphite Gray

Cat no.	Description	Price (Rs.)
STTSP06 .23	Tiny MCB Single Pole 6A	450.00
STTSP10 .23	Tiny MCB Single Pole 10A	450.00
STTSP16 .23	Tiny MCB Single Pole 16A	450.00
STTSP20 .23	Tiny MCB Single Pole 20A	450.00
STTSP25 .23	Tiny MCB Single Pole 25A	450.00
STTSP32 .23	Tiny MCB Single Pole 32A	450.00
STTDP06 .23	Tiny MCB Double Pole 6A	1120.00
STTDP10 .23	Tiny MCB Double Pole 10A	1120.00
STTDP16 .23	Tiny MCB Double Pole 16A	1120.00
STTDP20 .23	Tiny MCB Double Pole 20A	1120.00
STTDP25 .23	Tiny MCB Double Pole 25A	1120.00
STTDP32 .23	Tiny MCB Double Pole 32A	1120.00

119

Tiny Load Break Switch - Screw Mounting Type Graphite Gray

SLBDP32 .23	Tiny Load Break Switch Double Pole 32A	956.00
SLBDP50 .23	Tiny Load Break Switch Double Pole 50A	1045.00

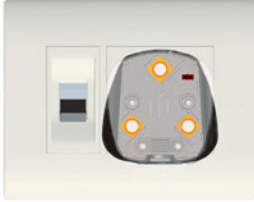

PU3MFT .01



PU4MFT .01



PU6MFT .01



PU3MBT .01



PU4MBT .01



PU6MBT .01

SQUARE Series

Pre-wired Power Units Frost White

Cat no.	Description	Price (Rs.)
PU3MFT .01	Power Unit Flush Type with MCB + 25A Plug & Socket	1274.00
PU3MBT .01	Power Unit in Surface Box with MCB + 25A Plug & Socket	1538.00
PU4MFT .01	Power Unit Flush Type with Starter + 25A Plug & Socket	1740.00
PU4MBT .01	Power Unit in Surface Box with Starter + 25A Plug & Socket	1870.00
PU6MFT .01	Power Unit Flush Type with MCB + Starter + 25A Plug & Socket	2754.00
PU6MBT .01	Power Unit in Surface Box MCB + Starter + 25A Plug & Socket	2824.00



MB501 .01
SB501 .01



MB503 .01
SB503 .01



MB504 .01
SB504 .01



MB506 .01
SB506 .01



MB508 .01
SB508 .01



MB509 .01
SB509 .01

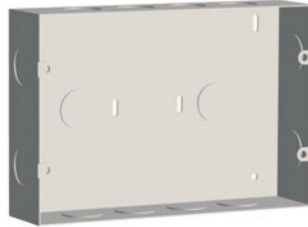

MB512 .01
SB512 .01



SM702 .01



SM703 .01



SM704 .01

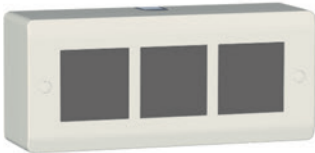

SM706 .01

Wiring Boxes

Superior Anti-Rust Stainless Steel Boxes Suitable for CUBE Series & SQUARE Series

Cat no.	Description	Suitable plate size in Cube Series	Suitable plate size in Square Series	Price (Rs.)
SB501 .01	75mm X 75mm X 50mm (3x3)	1M, 2M	1M, 2M	199.00
SB503 .01	100mm X 75mm X 50mm (4x3)	3M	1M, 2M, 3M	235.00
SB504 .01	135mm X 75mm X 50mm (5x3)	4M	4M	281.00
SB506 .01	210mm X 75mm X 50mm (8x3)	6M, 8M	6M	377.00
SB508 .01	230mm X 80mm X 50mm (9x3)	8M	8M	427.00
SB509 .01	135mm X 145mm X 50mm (5x5)	8M	8M	427.00
SB512 .01	145mm X 210mm X 50mm (8x6)	12M, 14M	12M	571.00
SB521 .01	210mm X 210mm X 50mm (8x8)	21M	18M	722.00

Metal Boxes Suitable for CUBE Series & SQUARE Series

123

MB501 .01	75mm X 75mm X 50mm (3x3)	1M, 2M	1M, 2M	128.00
MB503 .01	100mm X 75mm X 50mm (4x3)	3M	1M, 2M, 3M	158.00
MB504 .01	135mm X 75mm X 50mm (5x3)	4M	4M	192.00
MB506 .01	210mm X 75mm X 50mm (8x3)	6M, 8M	6M	270.00
MB508 .01	230mm X 80mm X 50mm (9x3)	8M	8M	303.00
MB509 .01	135mm X 145mm X 50mm (5x5)	8M	8M	303.00
MB512 .01	145mm X 210mm X 50mm (8x6)	12M, 14M	12M	430.00
MB521 .01	210mm X 210mm X 50mm (8x8)	21M	18M	548.00

Plastic Surface Boxes Frost White

SM702 .01	2 Module Surface Box 94mm X 94mm X 60mm (3.5 x 3.5)	232.00
SM703 .01	3 Module Surface Box 118mm X 94mm X 60mm (4.5 x 3.5)	262.00
SM704 .01	4 Module Surface Box 150mm X 94mm X 60mm (6 x 3.5)	306.00
SM706 .01	6 Module Surface Box 205mm X 94mm X 60mm (8 x 3.5)	363.00

CUBE Series exploded view

Solid, heavy products with fine precision engineering resulting in trouble-free operation.

Cover plate can be snap fit onto the frames after final painting of walls.

Strong and precise locks for sturdy mounting and easy removal.

124

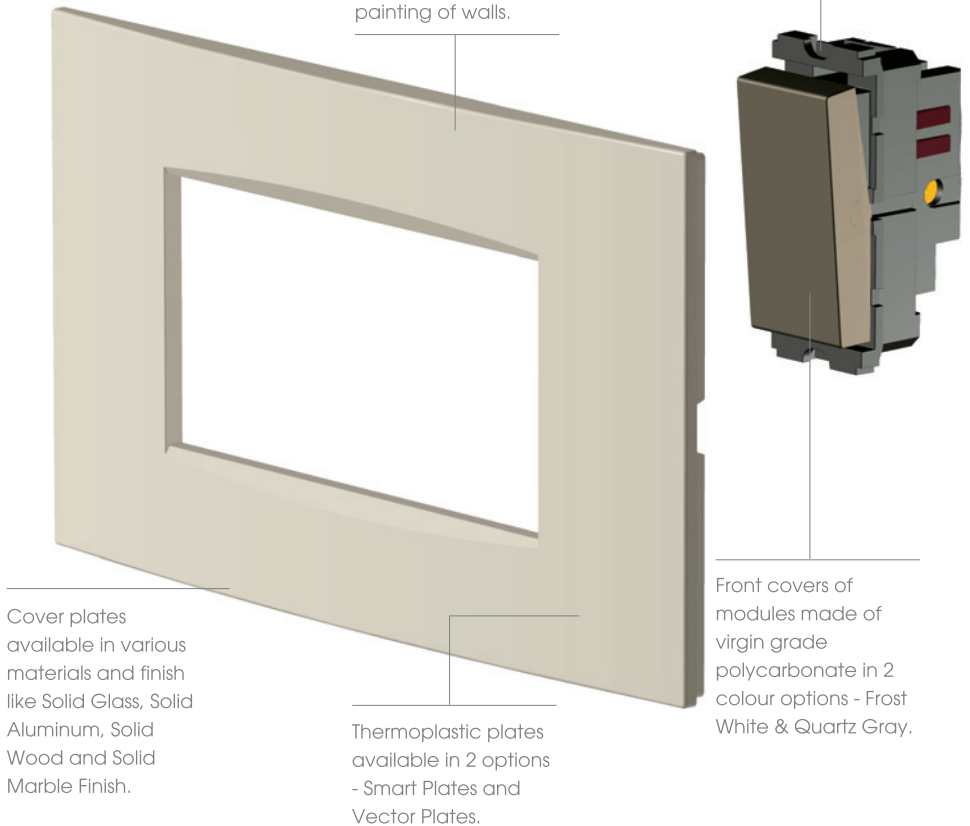

Thermoset material which can be seen in red colour is used inside to house the live metal parts. This material is extremely high heat resistant and does not melt on heating.

Sockets with elliptical spring loaded tubes for a firm and uniform grip on the plug pins ensuring unwavering contact.

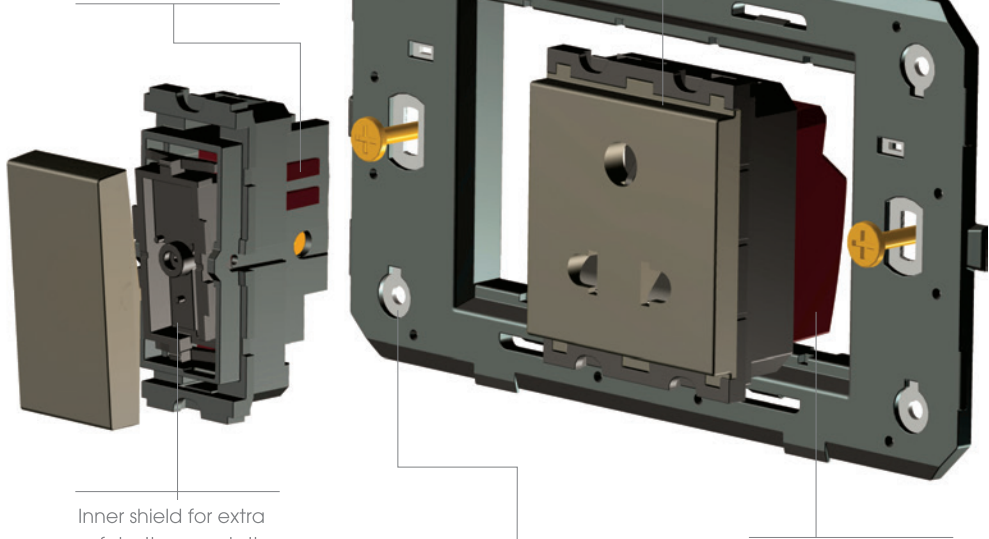

Inner shield for extra safety. It prevents the arcing from coming in contact with the front rocker. Also muffles the operating sound.

Bi-material frames that have high quality steel embedded inside thermoplastic. A result of advanced engineering, this combination leads to extra stiffness and tight tolerances for mounting of modules.

Live metal parts in sockets are enclosed in a housing made of thermoset material which is extremely high heat resistant and is capable of handling higher operating currents.

SQUARE Series exploded view

Time tested products which have evolved over a period of time - with the latest in technology.

Cover plate can be snap fit onto the frames after final painting of walls.

Modules are mounted on the frame using screws making it a fool-proof and durable mounting system.

126

Cover plates made from virgin grade, UV stabilized polycarbonate for a flawless glossy look that lasts longer.

Smart Plates that have a classic contour profile - a look unwavering by changes in fashion.

Front covers of modules made of virgin grade polycarbonate.

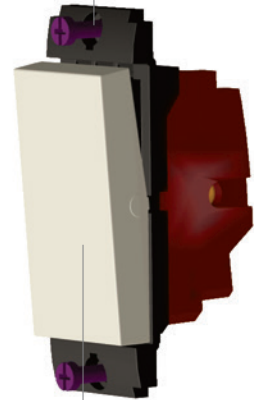
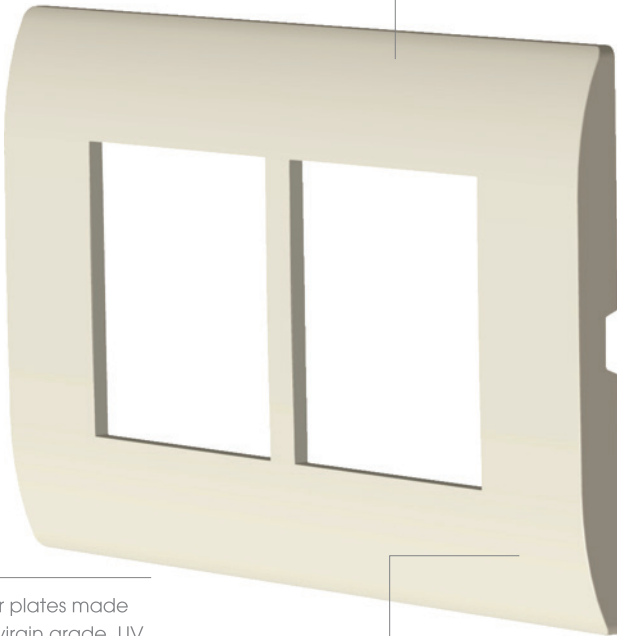

Thermoset material which can be seen in red colour is used inside to house the live metal parts. This material is extremely high heat resistant and does not melt on heating.

Sockets with elliptical spring loaded tubes for a firm and uniform grip on the plug pins ensuring unwavering contact.

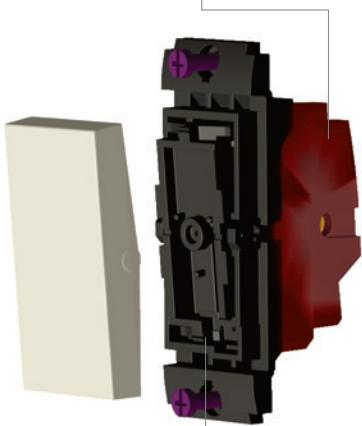

Inner shield for extra safety. It prevents the arcing from coming in contact with the front rocker. Also muffles the operating sound.

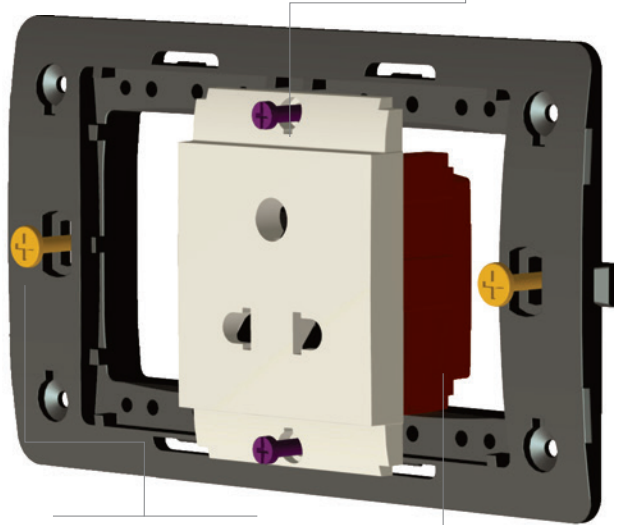

Tough frames that have unique locator slots that guide the modules to its accurate mounting location - thus ensuring uniform gaps in fitment. Steel channels at the rear give additional strength to the frames for rigidity.

Live metal parts in sockets are enclosed in thermoset material that is extremely high heat resistant and is capable of handling higher operating currents.





norisys[®]



@All rights reserved. Norisys is a registered trademark.

Wiring of electrical products should be done by trained professionals following all safety norms.

@Alle Rechte vorbehalten. Norisys ist eine eingetragene Marke.

Elektroinstallationen dürfen nur von entsprechend ausgebildeten Fachkräften unter Beachtung der maßgeblichen Sicherheitsrichtlinien vorgenommen werden.

Headquarters

Norisys Technology Private Limited
14/3 Mathura Road
Faridabad - 121 003, India

CIN: U31101DL1987PTC026630

Toll free: 1 800 11 1617

Tel: +91 11 49126360, 42657036

WhatsApp: +91 88 003 97858

Email: sales@norisys.com

Web: www.norisys.com

TG9 Series | Switches Sockets and Accessories
Product Information and Price List



A range that redefines luxury

Switches designed for aesthetics & performance

TG9 Series is a modular product range which is designed to satisfy the requirements of electrical installations in modern buildings.

The range includes switches, sockets, fan regulators & dimmers, hospitality products, acoustic and optical signaling products, cover plates in various materials etc.

Modules such as switches, sockets etc. are made to a standard size (module) and are mounted on frames.

Front plates can be changed at any time without disturbing the wiring - in order to adapt to changes in the building interiors.



TG9

5936.53.1



Solid Metal
Chrome Matt



Solid Metal
Chrome Glossy



Solid Metal
Mellow Gold









Plastic
Quartz Gray



Solid Metal
Black Glossy

Switches with solid metal levers

Metal and plastic options



			Price Rs.
	Switch 6A - 1 Gang - One-way 1 Module	Metal Chrome Glossy	T9100 .31 510.00
		Metal Chrome Matt	T9100 .32 561.00
		Metal Black Glossy	T9100 .33 591.00
		Metal Mellow Gold	T9100 .34 622.00
		Plastic Quartz Gray	T9100 .02 386.00
	Switch 6A - 1 Gang - One-way with indicator 1 Module	Metal Chrome Glossy	T9101 .31 733.00
		Metal Chrome Matt	T9101 .32 804.00
		Metal Black Glossy	T9101 .33 846.00
		Metal Mellow Gold	T9101 .34 892.00
		Plastic Quartz Gray	T9101 .02 554.00
	Switch 6A - 1 Gang - Two-way 1 Module	Metal Chrome Glossy	T9200 .31 680.00
		Metal Chrome Matt	T9200 .32 746.00
		Metal Black Glossy	T9200 .33 786.00
		Metal Mellow Gold	T9200 .34 826.00
		Plastic Quartz Gray	T9200 .02 515.00
	Switch 6A - 1 Gang - Two-way with indicator 1 Module	Metal Chrome Glossy	T9201 .31 980.00
		Metal Chrome Matt	T9201 .32 1074.00
		Metal Black Glossy	T9201 .33 1132.00
		Metal Mellow Gold	T9201 .34 1191.00
		Plastic Quartz Gray	T9201 .02 739.00
	Switch 16A - 1 Gang - One-way 1 Module	Metal Chrome Glossy	T9110 .31 807.00
		Metal Chrome Matt	T9110 .32 884.00
		Metal Black Glossy	T9110 .33 931.00
		Metal Mellow Gold	T9110 .34 980.00
		Plastic Quartz Gray	T9110 .02 610.00
	Switch 16A - 1 Gang - One-way with indicator 1 Module	Metal Chrome Glossy	T9111 .31 1003.00
		Metal Chrome Matt	T9111 .32 1099.00
		Metal Black Glossy	T9111 .33 1158.00
		Metal Mellow Gold	T9111 .34 1218.00
		Plastic Quartz Gray	T9111 .02 758.00
	Switch 16A - 1 Gang - Two-way 1 Module	Metal Chrome Glossy	T9210 .31 847.00
		Metal Chrome Matt	T9210 .32 928.00
		Metal Black Glossy	T9210 .33 978.00
		Metal Mellow Gold	T9210 .34 1028.00
		Plastic Quartz Gray	T9210 .02 640.00

TG9 Series



Switches with solid metal levers

Metal and plastic options







				Price Rs.
	Switch 16A - 1 Gang - Two-way with indicator 1 Module	Metal Chrome Glossy	T9211 .31	1096.00
		Metal Chrome Matt	T9211 .32	1202.00
		Metal Black Glossy	T9211 .33	1266.00
		Metal Mellow Gold	T9211 .34	1331.00
		Plastic Quartz Gray	T9211 .02	828.00
	Switch 6A - 1 Gang - Bell 1 Module	Metal Chrome Glossy	T9340 .31	727.00
		Metal Chrome Matt	T9340 .32	796.00
		Metal Black Glossy	T9340 .33	840.00
		Metal Mellow Gold	T9340 .34	883.00
		Plastic Quartz Gray	T9340 .02	547.00
	Switch 6A - 1 Gang - Bell with indicator 1 Module	Metal Chrome Glossy	T9341 .31	976.00
		Metal Chrome Matt	T9341 .32	1069.00
		Metal Black Glossy	T9341 .33	1128.00
		Metal Mellow Gold	T9341 .34	1186.00
		Plastic Quartz Gray	T9341 .02	737.00
	Switch 6A - 2 Gang - Both switches One-way 1 Module	Metal Chrome Glossy	T9300 .31	870.00
		Metal Chrome Matt	T9300 .32	956.00
		Metal Black Glossy	T9300 .33	1006.00
		Metal Mellow Gold	T9300 .34	1058.00
		Plastic Quartz Gray	T9300 .02	771.00
	Switch 6A - 2 Gang - Both switches One-way with indicator - 1 Module	Metal Chrome Glossy	T9301 .31	1196.00
		Metal Chrome Matt	T9301 .32	1310.00
		Metal Black Glossy	T9301 .33	1381.00
		Metal Mellow Gold	T9301 .34	1453.00
		Plastic Quartz Gray	T9301 .02	1124.00
	Switch 16A - 2 Gang - Both switches One-way 1 Module	Metal Chrome Glossy	T9310 .31	1305.00
		Metal Chrome Matt	T9310 .32	1431.00
		Metal Black Glossy	T9310 .33	1509.00
		Metal Mellow Gold	T9310 .34	1587.00
		Plastic Quartz Gray	T9310 .02	1212.00
	Switch 16A - 2 Gang - Both switches One-way with indicator - 1 Module	Metal Chrome Glossy	T9311 .31	1642.00
		Metal Chrome Matt	T9311 .32	1799.00
		Metal Black Glossy	T9311 .33	1896.00
		Metal Mellow Gold	T9311 .34	1996.00
		Plastic Quartz Gray	T9311 .02	1514.00



TG9 Series switches have contacts which provide very high current carrying capacity. The contact design, snap action pressure, wiping action between the contacts and use of high engineering grade materials result in minimum arcing. Reduction in arcing ensures a

Switches with solid metal levers

Metal and plastic options





			Price Rs.
	Switch 6A - 2 Gang - One-way + Bell with indicator - 1 Module	Metal Chrome Glossy	T9601 .31 1337.00
		Metal Chrome Matt	T9601 .32 1464.00
		Metal Black Glossy	T9601 .33 1542.00
		Metal Mellow Gold	T9601 .34 1622.00
		Plastic Quartz Gray	T9601 .02 1153.00
	Switch 6A - 2 Gang - Both switches Bell 1 Module	Metal Chrome Glossy	T9540 .31 1239.00
		Metal Chrome Matt	T9540 .32 1357.00
		Metal Black Glossy	T9540 .33 1429.00
		Metal Mellow Gold	T9540 .34 1504.00
		Plastic Quartz Gray	T9540 .02 1094.00
	Switch 6A - 2 Gang - Both switches Bell with indicator - 1 Module	Metal Chrome Glossy	T9541 .31 1593.00
		Metal Chrome Matt	T9541 .32 1742.00
		Metal Black Glossy	T9541 .33 1840.00
		Metal Mellow Gold	T9541 .34 1930.00
		Plastic Quartz Gray	T9541 .02 1494.00
	Switch 6A - 1 Gang - One-way + Blank 1 Module	Metal Chrome Glossy	T9700 .31 614.00
		Metal Chrome Matt	T9700 .32 672.00
		Metal Black Glossy	T9700 .33 709.00
		Metal Mellow Gold	T9700 .34 746.00
		Plastic Quartz Gray	T9700 .02 464.00
	Switch 6A - 1 Gang - One-way with indicator + Blank - 1 Module	Metal Chrome Glossy	T9701 .31 880.00
		Metal Chrome Matt	T9701 .32 966.00
		Metal Black Glossy	T9701 .33 1017.00
		Metal Mellow Gold	T9701 .34 1070.00
		Plastic Quartz Gray	T9701 .02 665.00
	Switch 6A - 1 Gang - Two-way + Blank 1 Module	Metal Chrome Glossy	T9800 .31 816.00
		Metal Chrome Matt	T9800 .32 896.00
		Metal Black Glossy	T9800 .33 943.00
		Metal Mellow Gold	T9800 .34 992.00
		Plastic Quartz Gray	T9800 .02 618.00
	Switch 6A - 1 Gang - Two-way with indicator + Blank - 1 Module	Metal Chrome Glossy	T9801 .31 1174.00
		Metal Chrome Matt	T9801 .32 1289.00
		Metal Black Glossy	T9801 .33 1358.00
		Metal Mellow Gold	T9801 .34 1429.00
		Plastic Quartz Gray	T9801 .02 887.00



LED indicators used in TG9 Series switches emit a soft, reassuring glow which is mild and soothing to the eyes. Use of high quality LEDs ensures a long life without flicker. Norisys engineers have been working diligently day after day in order to ensure consistent electrical, mechanical and thermal qualities in TG9 Series

Switches with solid metal levers

Metal and plastic options

			Price Rs.
	Switch 16A - 1 Gang - One-way + Blank 1 Module	Metal Chrome Glossy	T9710 .31 969.00
		Metal Chrome Matt	T9710 .32 1062.00
		Metal Black Glossy	T9710 .33 1118.00
		Metal Mellow Gold	T9710 .34 1176.00
		Plastic Quartz Gray	T9710 .02 731.00
	Switch 16A - 1 Gang - One-way with indicator + Blank - 1 Module	Metal Chrome Glossy	T9711 .31 1203.00
		Metal Chrome Matt	T9711 .32 1318.00
		Metal Black Glossy	T9711 .33 1390.00
		Metal Mellow Gold	T9711 .34 1462.00
		Plastic Quartz Gray	T9711 .02 908.00
	Switch 16A - 1 Gang - Two-way + Blank 1 Module	Metal Chrome Glossy	T9810 .31 1016.00
		Metal Chrome Matt	T9810 .32 1113.00
		Metal Black Glossy	T9810 .33 1173.00
		Metal Mellow Gold	T9810 .34 1235.00
		Plastic Quartz Gray	T9810 .02 768.00
	Switch 16A - 1 Gang - Two-way with indicator + Blank - 1 Module	Metal Chrome Glossy	T9811 .31 1315.00
		Metal Chrome Matt	T9811 .32 1442.00
		Metal Black Glossy	T9811 .33 1519.00
		Metal Mellow Gold	T9811 .34 1597.00
		Plastic Quartz Gray	T9811 .02 993.00
	Switch 6A - 1 Gang - Bell + Blank 1 Module	Metal Chrome Glossy	T9740 .31 872.00
		Metal Chrome Matt	T9740 .32 956.00
		Metal Black Glossy	T9740 .33 1008.00
		Metal Mellow Gold	T9740 .34 1060.00
		Plastic Quartz Gray	T9740 .02 656.00
	Switch 6A - 1 Gang - Bell with indicator + Blank 1 Module	Metal Chrome Glossy	T9741 .31 1172.00
		Metal Chrome Matt	T9741 .32 1283.00
		Metal Black Glossy	T9741 .33 1353.00
		Metal Mellow Gold	T9741 .34 1423.00
		Plastic Quartz Gray	T9741 .02 885.00
	Single Hole Blank 1 Module	Plastic Quartz Gray	T9770 .02 193.00

Smooth Operation

Mechanism designed for flawless movement

The transfer of motion from the dolly to the mechanism inside has been completely restructured. The front metal dolly is shielded from the live parts by a plastic component that is solidly riveted to it, thus providing adequate insulation. This plastic part also gives the

dolly the required cushioning for a smooth movement. The geometry of the spring in the contact mechanism is designed in a way so as to reduce the wear while switching even in arduous conditions.

An increase in the quantity of silver in the contacts also helps in reducing the electric arc considerably, thereby ensuring a trouble-free long life for the mechanism. Smoothness of operation imparts the luxury feel to the product. A soft click is all it takes to switch a light on.

TG9

5936.53.1



Switches with solid metal levers
Metal and plastic options

			Price Rs.
	<p>Double Hole Blank 1 Module</p>	<p>Plastic Quartz Gray</p>	<p>T9780 .02 271.00</p>



Solid Aluminium Plates with frames

Natural, Black and Dark Bronze

Price Rs.

1M Size Plate with 1 hole



Suitable for box size 3" x 3"
(75mm x 75mm)

Aluminium Natural	TA111 .04	2215.00
Aluminium Black	TA111 .05	2215.00
Aluminium Dark Bronze	TA111 .14	2437.00

1M Size Plate with 1M window



Suitable for box size 3" x 3"
(75mm x 75mm)

Aluminium Natural	TA301 .04	1761.00
Aluminium Black	TA301 .05	1761.00
Aluminium Dark Bronze	TA301 .14	1936.00

2M Size Plate with 2 holes



Suitable for box size 3" x 3"
(75mm x 75mm)

Aluminium Natural	TA212 .04	2215.00
Aluminium Black	TA212 .05	2215.00
Aluminium Dark Bronze	TA212 .14	2437.00

2M Size Plate with 4 holes



Suitable for box size 3" x 3"
(75mm x 75mm)

Aluminium Natural	TA222 .04	2215.00
Aluminium Black	TA222 .05	2215.00
Aluminium Dark Bronze	TA222 .14	2437.00

2M Size Plate with 2 holes + 1M window



Suitable for box size 3" x 3"
(75mm x 75mm)

Aluminium Natural	TA122 .04	2215.00
Aluminium Black	TA122 .05	2215.00
Aluminium Dark Bronze	TA122 .14	2437.00

2M Size Plate with 1 holes + 1M window



Suitable for box size 3" x 3"
(75mm x 75mm)

Aluminium Natural	TA112 .04	2215.00
Aluminium Black	TA112 .05	2215.00
Aluminium Dark Bronze	TA112 .14	2437.00

2M Size Plate with 2M window



Suitable for box size 3" x 3"
(75mm x 75mm)

Aluminium Natural	TA302 .04	1786.00
Aluminium Black	TA302 .05	1786.00
Aluminium Dark Bronze	TA302 .14	1966.00

3M Size Plate with 3 holes



Suitable for box size 4" x 3"
(100mm x 75mm)

Aluminium Natural	TA313 .04	2311.00
Aluminium Black	TA313 .05	2311.00
Aluminium Dark Bronze	TA313 .14	2542.00

3M Size Plate with 6 holes



Suitable for box size 4" x 3"
(100mm x 75mm)

Aluminium Natural	TA323 .04	2311.00
Aluminium Black	TA323 .05	2311.00
Aluminium Dark Bronze	TA323 .14	2542.00



Norisys TG9 Series plates set the standard for stylish design. They are available in top quality materials: Solid Aluminum, Solid Glass, Solid Wood, Solid Marble finish. The classy design creates an exclusive flair owing to the interaction of contrasts between the severity of optical forms and surface finish.

Each piece of Solid Aluminum plate is machined out of a solid block of aluminum to give it the sharp and clean look. These plates are available in natural, black and dark bronze colours that match very well with the modules. The complete look is a solid, well engineered and a smart composition.

Solid Aluminium Plates with frames

Natural, Black and Dark Bronze

Price Rs.

3M Size Plate with 2 holes + 2M window



Suitable for box size 4" x 3"
(100mm x 75mm)

Aluminium Natural	TA123 .04	2311.00
Aluminium Black	TA123 .05	2311.00
Aluminium Dark Bronze	TA123 .14	2542.00

3M Size Plate with 1 hole + 2M window



Suitable for box size 4" x 3"
(100mm x 75mm)

Aluminium Natural	TA113 .04	2311.00
Aluminium Black	TA113 .05	2311.00
Aluminium Dark Bronze	TA113 .14	2542.00

3M Size Plate with 3M window



Suitable for box size 4" x 3"
(100mm x 75mm)

Aluminium Natural	TA303 .04	1894.00
Aluminium Black	TA303 .05	1894.00
Aluminium Dark Bronze	TA303 .14	2084.00

4M Size Plate with 4 holes



For box size 5" x 3"
(135mm x 75mm)

Aluminium Natural	TA414 .04	2617.00
Aluminium Black	TA414 .05	2617.00
Aluminium Dark Bronze	TA414 .14	2879.00

4M Size Plate with 8 holes



For box size 5" x 3"
(135mm x 75mm)

Aluminium Natural	TA424 .04	2617.00
Aluminium Black	TA424 .05	2617.00
Aluminium Dark Bronze	TA424 .14	2879.00

4M Size Plate with 2 holes + 2M window



For box size 5" x 3"
(135mm x 75mm)

Aluminium Natural	TA214 .04	2617.00
Aluminium Black	TA214 .05	2617.00
Aluminium Dark Bronze	TA214 .14	2879.00

4M Size Plate with 4 holes + 2M window



For box size 5" x 3"
(135mm x 75mm)

Aluminium Natural	TA224 .04	2617.00
Aluminium Black	TA224 .05	2617.00
Aluminium Dark Bronze	TA224 .14	2879.00

4M Size Plate with 2 holes + 3M window



For box size 5" x 3"
(135mm x 75mm)

Aluminium Natural	TA124 .04	2617.00
Aluminium Black	TA124 .05	2617.00
Aluminium Dark Bronze	TA124 .14	2879.00

4M Size Plate with 4M window



For box size 5" x 3"
(135mm x 75mm)

Aluminium Natural	TA304 .04	2128.00
Aluminium Black	TA304 .05	2128.00
Aluminium Dark Bronze	TA304 .14	2341.00

TG9 Series



Solid Aluminium Plates with frames
Natural, Black and Dark Bronze

			Price Rs.
 <p>6M Size Plate with 6 holes</p> <p>For box size 8" x 3" (210mm x 75mm)</p>	Aluminium Natural	TA616 .04	2889.00
	Aluminium Black	TA616 .05	2889.00
	Aluminium Dark Bronze	TA616 .14	3178.00
 <p>6M Size Plate with 12 holes</p> <p>For box size 8" x 3" (210mm x 75mm)</p>	Aluminium Natural	TA626 .04	2889.00
	Aluminium Black	TA626 .05	2889.00
	Aluminium Dark Bronze	TA626 .14	3178.00
 <p>6M Size Plate with 4 holes + 2M window</p> <p>For box size 8" x 3" (210mm x 75mm)</p>	Aluminium Natural	TA416 .04	2889.00
	Aluminium Black	TA416 .05	2889.00
	Aluminium Dark Bronze	TA416 .14	3178.00
 <p>6M Size Plate with 8 holes + 2M window</p> <p>For box size 8" x 3" (210mm x 75mm)</p>	Aluminium Natural	TA426 .04	2889.00
	Aluminium Black	TA426 .05	2889.00
	Aluminium Dark Bronze	TA426 .14	3178.00
 <p>6M Size Plate with 4 holes + 4M window</p> <p>For box size 8" x 3" (210mm x 75mm)</p>	Aluminium Natural	TA226 .04	2889.00
	Aluminium Black	TA226 .05	2889.00
	Aluminium Dark Bronze	TA226 .14	3178.00
 <p>6M Size Plate with 2 holes + 2Mx2 window</p> <p>For box size 8" x 3" (210mm x 75mm)</p>	Aluminium Natural	TA216 .04	2889.00
	Aluminium Black	TA216 .05	2889.00
	Aluminium Dark Bronze	TA216 .14	3178.00
 <p>6M Size Plate with 6 holes + 3M window</p> <p>For box size 8" x 3" (210mm x 75mm)</p>	Aluminium Natural	TA326 .04	2889.00
	Aluminium Black	TA326 .05	2889.00
	Aluminium Dark Bronze	TA326 .14	3178.00
 <p>6M Size Plate with 6M window</p> <p>For box size 8" x 3" (210mm x 75mm)</p>	Aluminium Natural	TA306 .04	2330.00
	Aluminium Black	TA306 .05	2330.00
	Aluminium Dark Bronze	TA306 .14	2563.00
 <p>8M Size Plate with 8 hole</p> <p>For box size 9"x3" or 8"x3" (230 / 210mm x 75mm)</p>	Aluminium Natural	TA818 .04	3154.00
	Aluminium Black	TA818 .05	3154.00
	Aluminium Dark Bronze	TA818 .14	3469.00

TG9 Series products are designed for durability and flawless performance even in arduous conditions. The products are mounted in a way that the entire pressure of wires in the junction box is borne entirely by a sturdy bi-material frame.

The bi-material support frames in TG9 Series is the result of several man-hours of research and

development. Bi-material frames are a combination of steel and engineering grade plastic.

Cover plates have different combinations of holes and windows. Holes are meant for switches and fan regulators, while the windows are meant for all other modules.



TG9

5936.53.1



Solid Aluminium
Natural



Solid Aluminium
Black



Solid Aluminium
Dark Bronze

Solid Aluminium Plates with frames

Natural, Black and Dark Bronze

Price Rs.

8M Size Plate with 16 holes



For box size 9"x3" or 8"x3"
(230 / 210mm x 75mm)

Aluminium Natural	TA828 .04	3154.00
Aluminium Black	TA828 .05	3154.00
Aluminium Dark Bronze	TA828 .14	3469.00

8M Size Plate with 6 holes + 2M window



For box size 9"x3" or 8"x3"
(230 / 210mm x 75mm)

Aluminium Natural	TA618 .04	3154.00
Aluminium Black	TA618 .05	3154.00
Aluminium Dark Bronze	TA618 .14	3469.00

8M Size Plate with 4 holes + 4M window



For box size 9"x3" or 8"x3"
(230 / 210mm x 75mm)

Aluminium Natural	TA418 .04	3154.00
Aluminium Black	TA418 .05	3154.00
Aluminium Dark Bronze	TA418 .14	3469.00

8M Size Plate with 8 holes + 4M window



For box size 9"x3" or 8"x3"
(230 / 210mm x 75mm)

Aluminium Natural	TA428 .04	3154.00
Aluminium Black	TA428 .05	3154.00
Aluminium Dark Bronze	TA428 .14	3469.00

8M Size Plate with 4 holes + 6M window



For box size 9"x3" or 8"x3"
(230 / 210mm x 75mm)

Aluminium Natural	TA228 .04	3154.00
Aluminium Black	TA228 .05	3154.00
Aluminium Dark Bronze	TA228 .14	3469.00

8M Size Plate with 5 holes + 3M window



For box size 9"x3" or 8"x3"
(230 / 210mm x 75mm)

Aluminium Natural	TA518 .04	3154.00
Aluminium Black	TA518 .05	3154.00
Aluminium Dark Bronze	TA518 .14	3469.00

8M Size Plate with 10 holes + 3M window



For box size 9"x3" or 8"x3"
(230 / 210mm x 75mm)

Aluminium Natural	TA528 .04	3154.00
Aluminium Black	TA528 .05	3154.00
Aluminium Dark Bronze	TA528 .14	3469.00

8M Size Plate with 12 holes + 2M window



For box size 9"x3" or 8"x3"
(230 / 210mm x 75mm)

Aluminium Natural	TA628 .04	3154.00
Aluminium Black	TA628 .05	3154.00
Aluminium Dark Bronze	TA628 .14	3469.00

8M Size Plate with 8M window



For box size 9"x3" or 8"x3"
(230 / 210mm x 75mm)

Aluminium Natural	TA308 .04	2523.00
Aluminium Black	TA308 .05	2523.00
Aluminium Dark Bronze	TA308 .14	2778.00

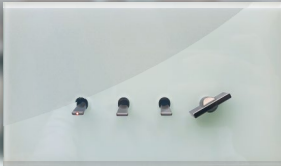

Solid glass plates are made of engineered glass which is tempered and toughened to make it rugged and to impart a nice uniform lustre. Solid glass plates are available in Ice White, Metal Gray, Smoked Silver, Solid Black and Ultra White colours. Minimalistic design with various optical forms in glass plates and metallic switches makes them an

Solid Glass Plates with frames

Various colour options

			Price Rs.
 <p>1M Size Plate with 1 hole Suitable for box size 3" x 3" (75mm x 75mm)</p>	Ice White	TG111 .08	1561.00
	Metal Gray	TG111 .09	1561.00
	Smoked Silver	TG111 .18	1561.00
	Solid Black	TG111 .19	1561.00
	Ultra White	TG111 .38	1874.00
	<hr/>		
 <p>1M Size Plate with 1M window Suitable for box size 3" x 3" (75mm x 75mm)</p>	Ice White	TG301 .08	1260.00
	Metal Gray	TG301 .09	1260.00
	Smoked Silver	TG301 .18	1260.00
	Solid Black	TG301 .19	1260.00
	Ultra White	TG301 .38	1722.00
	<hr/>		
 <p>2M Size Plate with 2 holes Suitable for box size 3" x 3" (75mm x 75mm)</p>	Ice White	TG212 .08	1561.00
	Metal Gray	TG212 .09	1561.00
	Smoked Silver	TG212 .18	1561.00
	Solid Black	TG212 .19	1561.00
	Ultra White	TG212 .38	1874.00
	<hr/>		
 <p>2M Size Plate with 4 holes Suitable for box size 3" x 3" (75mm x 75mm)</p>	Ice White	TG222 .08	1561.00
	Metal Gray	TG222 .09	1561.00
	Smoked Silver	TG222 .18	1561.00
	Solid Black	TG222 .19	1561.00
	Ultra White	TG222 .38	1874.00
	<hr/>		
 <p>2M Size Plate with 2 holes + 1M window Suitable for box size 3" x 3" (75mm x 75mm)</p>	Ice White	TG122 .08	1561.00
	Metal Gray	TG122 .09	1561.00
	Smoked Silver	TG122 .18	1561.00
	Solid Black	TG122 .19	1561.00
	Ultra White	TG122 .38	1874.00
	<hr/>		
 <p>2M Size Plate with 1 holes + 1M window Suitable for box size 3" x 3" (75mm x 75mm)</p>	Ice White	TG112 .08	1561.00
	Metal Gray	TG112 .09	1561.00
	Smoked Silver	TG112 .18	1561.00
	Solid Black	TG112 .19	1561.00
	Ultra White	TG112 .38	1874.00
	<hr/>		
 <p>2M Size Plate with 2M window Suitable for box size 3" x 3" (75mm x 75mm)</p>	Ice White	TG302 .08	1280.00
	Metal Gray	TG302 .09	1280.00
	Smoked Silver	TG302 .18	1280.00
	Solid Black	TG302 .19	1280.00
	Ultra White	TG302 .38	1773.00
	<hr/>		



Solid Glass
Ice White



Solid Glass
Solid Black

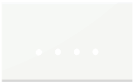

Solid Glass
Ultra White



Solid Glass
Smoked Silver



Solid Glass
Metal Gray

Modules are mounted on bi-material frames using a unique snap-fit mechanism. This snap-fit mechanism is highly accurate thereby ensuring that all modules fit comfortably without the need of force. Location of the modules on the bi-material frames is controlled by this mechanism and it maintains uniform gaps between the modules. It uses locks that remain free from any

Solid Glass Plates with frames

Various colour options

			Price Rs.
 <p>3M Size Plate with 3 holes Suitable for box size 4" x 3" (100mm x 75mm)</p>	Ice White	TG313 .08	1655.00
	Metal Gray	TG313 .09	1655.00
	Smoked Silver	TG313 .18	1655.00
	Solid Black	TG313 .19	1655.00
	Ultra White	TG313 .38	1986.00
	<hr/>		
 <p>3M Size Plate with 6 holes Suitable for box size 4" x 3" (100mm x 75mm)</p>	Ice White	TG323 .08	1655.00
	Metal Gray	TG323 .09	1655.00
	Smoked Silver	TG323 .18	1655.00
	Solid Black	TG323 .19	1655.00
	Ultra White	TG323 .38	1986.00
	<hr/>		
 <p>3M Size Plate with 2 holes + 2M window Suitable for box size 4" x 3" (100mm x 75mm)</p>	Ice White	TG123 .08	1655.00
	Metal Gray	TG123 .09	1655.00
	Smoked Silver	TG123 .18	1655.00
	Solid Black	TG123 .19	1655.00
	Ultra White	TG123 .38	1986.00
	<hr/>		
 <p>3M Size Plate with 1 hole + 2M window Suitable for box size 4" x 3" (100mm x 75mm)</p>	Ice White	TG113 .08	1655.00
	Metal Gray	TG113 .09	1655.00
	Smoked Silver	TG113 .18	1655.00
	Solid Black	TG113 .19	1655.00
	Ultra White	TG113 .38	1986.00
	<hr/>		
 <p>3M Size Plate with 3M window Suitable for box size 4" x 3" (100mm x 75mm)</p>	Ice White	TG303 .08	1356.00
	Metal Gray	TG303 .09	1356.00
	Smoked Silver	TG303 .18	1356.00
	Solid Black	TG303 .19	1356.00
	Ultra White	TG303 .38	1853.00
	<hr/>		
 <p>4M Size Plate with 4 holes For box size 5" x 3" (135mm x 75mm)</p>	Ice White	TG414 .08	1874.00
	Metal Gray	TG414 .09	1874.00
	Smoked Silver	TG414 .18	1874.00
	Solid Black	TG414 .19	1874.00
	Ultra White	TG414 .38	2249.00
	<hr/>		
 <p>4M Size Plate with 8 holes For box size 5" x 3" (135mm x 75mm)</p>	Ice White	TG424 .08	1874.00
	Metal Gray	TG424 .09	1874.00
	Smoked Silver	TG424 .18	1874.00
	Solid Black	TG424 .19	1874.00
	Ultra White	TG424 .38	2249.00
	<hr/>		

Sustainable Materials Advantage

Materials chosen for functionality and sustainability

Materials chosen for TG9 series products reflect the Core values of Norisys that guide everything we do as a company and strongly influences the decisions our employees make at work. It is our long standing commitment and it exemplifies the way we operate. These values are timeless and foundational for a sustainable strategy that positions Norisys for long-term growth and strengthens our connection within local communities.

We are committed to protecting the health and safety of the people connected with us in any way - our employees, our contractors, our customers, and the people in the communities

where we operate. We search for science-enabled, sustainable solutions for our customers and always strive to manage businesses while protecting the environment and preserving the earth's natural resources — for today and for future generations.

At Norisys, we regularly engage in multiple sustainability initiatives. We are working towards minimal waste in our operations — not only inside the four walls of the plants, but also across the complete lifecycle of the

TG9

5936.53.1



Solid Glass Plates with frames

Various colour options

			Price Rs.
 <p>For box size 5" x 3" (135mm x 75mm)</p>	4M Size Plate with 2 holes + 2M window	Ice White	TG214 .08 1874.00
	Metal Gray	TG214 .09 1874.00	
	Smoked Silver	TG214 .18 1874.00	
	Solid Black	TG214 .19 1874.00	
	Ultra White	TG214 .38 2249.00	
 <p>For box size 5" x 3" (135mm x 75mm)</p>	4M Size Plate with 4 holes + 2M window	Ice White	TG224 .08 1874.00
	Metal Gray	TG224 .09 1874.00	
	Smoked Silver	TG224 .18 1874.00	
	Solid Black	TG224 .19 1874.00	
	Ultra White	TG224 .38 2249.00	
 <p>For box size 5" x 3" (135mm x 75mm)</p>	4M Size Plate with 2 holes + 3M window	Ice White	TG124 .08 1874.00
	Metal Gray	TG124 .09 1874.00	
	Smoked Silver	TG124 .18 1874.00	
	Solid Black	TG124 .19 1874.00	
	Ultra White	TG124 .38 2249.00	
 <p>For box size 5" x 3" (135mm x 75mm)</p>	4M Size Plate with 4M window	Ice White	TG304 .08 1524.00
	Metal Gray	TG304 .09 1524.00	
	Smoked Silver	TG304 .18 1524.00	
	Solid Black	TG304 .19 1524.00	
	Ultra White	TG304 .38 2082.00	
 <p>For box size 8" x 3" (210mm x 75mm)</p>	6M Size Plate with 6 holes	Ice White	TG616 .08 2084.00
	Metal Gray	TG616 .09 2084.00	
	Smoked Silver	TG616 .18 2084.00	
	Solid Black	TG616 .19 2084.00	
	Ultra White	TG616 .38 2501.00	
 <p>For box size 8" x 3" (210mm x 75mm)</p>	6M Size Plate with 12 holes	Ice White	TG626 .08 2084.00
	Metal Gray	TG626 .09 2084.00	
	Smoked Silver	TG626 .18 2084.00	
	Solid Black	TG626 .19 2084.00	
	Ultra White	TG626 .38 2501.00	
 <p>For box size 8" x 3" (210mm x 75mm)</p>	6M Size Plate with 4 holes + 2M window	Ice White	TG416 .08 2084.00
	Metal Gray	TG416 .09 2084.00	
	Smoked Silver	TG416 .18 2084.00	
	Solid Black	TG416 .19 2084.00	
	Ultra White	TG416 .38 2501.00	

Bi-material Frames Advantage

Frames that are designed for tough performance

TG9 Series products are designed for tough performance. The products are mounted in a way that the entire pressure of wires in the junction box is borne entirely by a sturdy bi-material frame.

The bi-material support frames in TG9 Series is the result of several man-hours of research and development. The bi-material frames are made of a combination of

steel and engineering grade plastic. In this design, the steel structure is embedded into plastic. The steel inside gives the bi-material frame a rigid structure while the plastic provides the anti-rust and insulation properties.

Modules are mounted using



a unique snap-fit mechanism. The snap-fit mechanism is highly accurate, thereby ensuring comfortable fitment of all modules without the need for excessive force. Location of the modules on the frames is controlled by this mechanism which maintains uniform gaps between the modules. This mechanism uses interlocking that

TG9

5936.53.1



Solid Glass Plates with frames

Various colour options

			Price Rs.
 <p>6M Size Plate with 8 holes + 2M window For box size 8" x 3" (210mm x 75mm)</p>	Ice White	TG426 .08	2084.00
	Metal Gray	TG426 .09	2084.00
	Smoked Silver	TG426 .18	2084.00
	Solid Black	TG426 .19	2084.00
	Ultra White	TG426 .38	2501.00
	<hr/>		
 <p>6M Size Plate with 4 holes + 4M window For box size 8" x 3" (210mm x 75mm)</p>	Ice White	TG226 .08	2084.00
	Metal Gray	TG226 .09	2084.00
	Smoked Silver	TG226 .18	2084.00
	Solid Black	TG226 .19	2084.00
	Ultra White	TG226 .38	2501.00
	<hr/>		
 <p>6M Size Plate with 2 holes + 2Mx2 window For box size 8" x 3" (210mm x 75mm)</p>	Ice White	TG216 .08	2084.00
	Metal Gray	TG216 .09	2084.00
	Smoked Silver	TG216 .18	2084.00
	Solid Black	TG216 .19	2084.00
	Ultra White	TG216 .38	2501.00
	<hr/>		
 <p>6M Size Plate with 6 holes + 3M window For box size 8" x 3" (210mm x 75mm)</p>	Ice White	TG326 .08	2084.00
	Metal Gray	TG326 .09	2084.00
	Smoked Silver	TG326 .18	2084.00
	Solid Black	TG326 .19	2084.00
	Ultra White	TG326 .38	2501.00
	<hr/>		
 <p>6M Size Plate with 6M window For box size 8" x 3" (210mm x 75mm)</p>	Ice White	TG306 .08	1668.00
	Metal Gray	TG306 .09	1668.00
	Smoked Silver	TG306 .18	1668.00
	Solid Black	TG306 .19	1668.00
	Ultra White	TG306 .38	2286.00
	<hr/>		
 <p>8M Size Plate with 8 hole For box size 9"x3" or 8"x3" (230 / 210mm x 75mm)</p>	Ice White	TG818 .08	2259.00
	Metal Gray	TG818 .09	2259.00
	Smoked Silver	TG818 .18	2259.00
	Solid Black	TG818 .19	2259.00
	Ultra White	TG818 .38	2710.00
	<hr/>		
 <p>8M Size Plate with 16 holes For box size 9"x3" or 8"x3" (230 / 210mm x 75mm)</p>	Ice White	TG828 .08	2259.00
	Metal Gray	TG828 .09	2259.00
	Smoked Silver	TG828 .18	2259.00
	Solid Black	TG828 .19	2259.00
	Ultra White	TG828 .38	2710.00
	<hr/>		







TG9

5936.53.1



Solid Glass Plates with frames

Various colour options

			Price Rs.
 <p>8M Size Plate with 6 holes + 2M window</p> <p>For box size 9"x3" or 8"x3" (230 / 210mm x 75mm)</p>	Ice White	TG618 .08	2259.00
	Metal Gray	TG618 .09	2259.00
	Smoked Silver	TG618 .18	2259.00
	Solid Black	TG618 .19	2259.00
	Ultra White	TG618 .38	2710.00
	<hr/>		
 <p>8M Size Plate with 4 holes + 4M window</p> <p>For box size 9"x3" or 8"x3" (230 / 210mm x 75mm)</p>	Ice White	TG418 .08	2259.00
	Metal Gray	TG418 .09	2259.00
	Smoked Silver	TG418 .18	2259.00
	Solid Black	TG418 .19	2259.00
	Ultra White	TG418 .38	2710.00
	<hr/>		
 <p>8M Size Plate with 8 holes + 4M window</p> <p>For box size 9"x3" or 8"x3" (230 / 210mm x 75mm)</p>	Ice White	TG428 .08	2259.00
	Metal Gray	TG428 .09	2259.00
	Smoked Silver	TG428 .18	2259.00
	Solid Black	TG428 .19	2259.00
	Ultra White	TG428 .38	2710.00
	<hr/>		
 <p>8M Size Plate with 4 holes + 6M window</p> <p>For box size 9"x3" or 8"x3" (230 / 210mm x 75mm)</p>	Ice White	TG228 .08	2259.00
	Metal Gray	TG228 .09	2259.00
	Smoked Silver	TG228 .18	2259.00
	Solid Black	TG228 .19	2259.00
	Ultra White	TG228 .38	2710.00
	<hr/>		
 <p>8M Size Plate with 5 holes + 3M window</p> <p>For box size 9"x3" or 8"x3" (230 / 210mm x 75mm)</p>	Ice White	TG518 .08	2259.00
	Metal Gray	TG518 .09	2259.00
	Smoked Silver	TG518 .18	2259.00
	Solid Black	TG518 .19	2259.00
	Ultra White	TG518 .38	2710.00
	<hr/>		
 <p>8M Size Plate with 10 holes + 3M window</p> <p>For box size 9"x3" or 8"x3" (230 / 210mm x 75mm)</p>	Ice White	TG528 .08	2259.00
	Metal Gray	TG528 .09	2259.00
	Smoked Silver	TG528 .18	2259.00
	Solid Black	TG528 .19	2259.00
	Ultra White	TG528 .38	2710.00
	<hr/>		
 <p>8M Size Plate with 12 holes + 2M window</p> <p>For box size 9"x3" or 8"x3" (230 / 210mm x 75mm)</p>	Ice White	TG628 .08	2259.00
	Metal Gray	TG628 .09	2259.00
	Smoked Silver	TG628 .18	2259.00
	Solid Black	TG628 .19	2259.00
	Ultra White	TG628 .38	2710.00
	<hr/>		



Solid Glass Plates with frames

Various colour options

8M Size Plate with 8M window







For box size 9"x3" or 8"x3"
(230 / 210mm x 75mm)

Ice White	TG308 .08	1807.00
Metal Gray	TG308 .09	1807.00
Smoked Silver	TG308 .18	1807.00
Solid Black	TG308 .19	1807.00
Ultra White	TG308 .38	2485.00



Solid Marble Finish Plates with frames

Various colour and pattern options

			Price Rs.
 <p>1M Size Plate with 1 hole Suitable for box size 3" x 3" (75mm x 75mm)</p>	Sparkle White	TM111 .10	1432.00
	Terra Beige	TM111 .11	1432.00
	Salt White	TM111 .12	1576.00
	Onyx White	TM111 .13	1576.00
	<hr/>		
 <p>1M Size Plate with 1M window Suitable for box size 3" x 3" (75mm x 75mm)</p>	Sparkle White	TM301 .10	1156.00
	Terra Beige	TM301 .11	1156.00
	Salt White	TM301 .12	1273.00
	Onyx White	TM301 .13	1273.00
<hr/>			
 <p>2M Size Plate with 2 holes Suitable for box size 3" x 3" (75mm x 75mm)</p>	Sparkle White	TM212 .10	1432.00
	Terra Beige	TM212 .11	1432.00
	Salt White	TM212 .12	1576.00
	Onyx White	TM212 .13	1576.00
<hr/>			
 <p>2M Size Plate with 4 holes Suitable for box size 3" x 3" (75mm x 75mm)</p>	Sparkle White	TM222 .10	1432.00
	Terra Beige	TM222 .11	1432.00
	Salt White	TM222 .12	1576.00
	Onyx White	TM222 .13	1576.00
<hr/>			
 <p>2M Size Plate with 2 holes + 1M window Suitable for box size 3" x 3" (75mm x 75mm)</p>	Sparkle White	TM122 .10	1432.00
	Terra Beige	TM122 .11	1432.00
	Salt White	TM122 .12	1576.00
	Onyx White	TM122 .13	1576.00
<hr/>			
 <p>2M Size Plate with 1 holes + 1M window Suitable for box size 3" x 3" (75mm x 75mm)</p>	Sparkle White	TM112 .10	1432.00
	Terra Beige	TM112 .11	1432.00
	Salt White	TM112 .12	1576.00
	Onyx White	TM112 .13	1576.00
<hr/>			
 <p>2M Size Plate with 2M window Suitable for box size 3" x 3" (75mm x 75mm)</p>	Sparkle White	TM302 .10	1174.00
	Terra Beige	TM302 .11	1174.00
	Salt White	TM302 .12	1292.00
	Onyx White	TM302 .13	1292.00
<hr/>			
 <p>3M Size Plate with 3 holes Suitable for box size 4" x 3" (100mm x 75mm)</p>	Sparkle White	TM313 .10	1517.00
	Terra Beige	TM313 .11	1517.00
	Salt White	TM313 .12	1670.00
	Onyx White	TM313 .13	1670.00



Solid Marble Finish
Sparkle White



Solid Marble Finish
Terra Beige



Solid Marble Finish
Salt White



Solid Marble Finish
Onyx White

Solid Marble finish plates are individually machined from solid blocks so that the end product is a crisp clean-cut flat plate that bears modern aesthetics. The Sparkle White and Salt White options match very well with white stones whereas the Onyx White and Terra Beige options



match very well with stones from the Beige and Brown family. Once mounted along with the TG9 Series modules, it creates a confluence of technical accuracy with a natural feel.

5936.53.1



Solid Marble Finish Plates with frames

Various colour and pattern options

			Price Rs.
 <p>Suitable for box size 4" x 3" (100mm x 75mm)</p>	Sparkle White	TM323 .10	1517.00
	Terra Beige	TM323 .11	1517.00
	Salt White	TM323 .12	1670.00
	Onyx White	TM323 .13	1670.00
	<hr/>		
 <p>Suitable for box size 4" x 3" (100mm x 75mm)</p>	Sparkle White	TM123 .10	1517.00
	Terra Beige	TM123 .11	1517.00
	Salt White	TM123 .12	1670.00
	Onyx White	TM123 .13	1670.00
	<hr/>		
 <p>Suitable for box size 4" x 3" (100mm x 75mm)</p>	Sparkle White	TM113 .10	1517.00
	Terra Beige	TM113 .11	1517.00
	Salt White	TM113 .12	1670.00
	Onyx White	TM113 .13	1670.00
	<hr/>		
 <p>Suitable for box size 4" x 3" (100mm x 75mm)</p>	Sparkle White	TM303 .10	1244.00
	Terra Beige	TM303 .11	1244.00
	Salt White	TM303 .12	1368.00
	Onyx White	TM303 .13	1368.00
	<hr/>		
 <p>For box size 5" x 3" (135mm x 75mm)</p>	Sparkle White	TM414 .10	1719.00
	Terra Beige	TM414 .11	1719.00
	Salt White	TM414 .12	1890.00
	Onyx White	TM414 .13	1890.00
	<hr/>		
 <p>For box size 5" x 3" (135mm x 75mm)</p>	Sparkle White	TM424 .10	1719.00
	Terra Beige	TM424 .11	1719.00
	Salt White	TM424 .12	1890.00
	Onyx White	TM424 .13	1890.00
	<hr/>		
 <p>For box size 5" x 3" (135mm x 75mm)</p>	Sparkle White	TM214 .10	1719.00
	Terra Beige	TM214 .11	1719.00
	Salt White	TM214 .12	1890.00
	Onyx White	TM214 .13	1890.00
	<hr/>		
 <p>For box size 5" x 3" (135mm x 75mm)</p>	Sparkle White	TM224 .10	1719.00
	Terra Beige	TM224 .11	1719.00
	Salt White	TM224 .12	1890.00
	Onyx White	TM224 .13	1890.00
	<hr/>		



Solid Marble Finish Plates with frames

Various colour and pattern options

			Price Rs.
4M Size Plate with 2 holes + 3M window  <p>For box size 5" x 3" (135mm x 75mm)</p>	Sparkle White	TM124 .10	1719.00
	Terra Beige	TM124 .11	1719.00
	Salt White	TM124 .12	1890.00
	Onyx White	TM124 .13	1890.00
4M Size Plate with 4M window  <p>For box size 5" x 3" (135mm x 75mm)</p>	Sparkle White	TM304 .10	1398.00
	Terra Beige	TM304 .11	1398.00
	Salt White	TM304 .12	1537.00
	Onyx White	TM304 .13	1537.00
6M Size Plate with 6 holes  <p>For box size 8" x 3" (210mm x 75mm)</p>	Sparkle White	TM616 .10	1898.00
	Terra Beige	TM616 .11	1898.00
	Salt White	TM616 .12	2089.00
	Onyx White	TM616 .13	2089.00
6M Size Plate with 12 holes  <p>For box size 8" x 3" (210mm x 75mm)</p>	Sparkle White	TM626 .10	1898.00
	Terra Beige	TM626 .11	1898.00
	Salt White	TM626 .12	2089.00
	Onyx White	TM626 .13	2089.00
6M Size Plate with 4 holes + 2M window  <p>For box size 8" x 3" (210mm x 75mm)</p>	Sparkle White	TM416 .10	1898.00
	Terra Beige	TM416 .11	1898.00
	Salt White	TM416 .12	2089.00
	Onyx White	TM416 .13	2089.00
6M Size Plate with 8 holes + 2M window  <p>For box size 8" x 3" (210mm x 75mm)</p>	Sparkle White	TM426 .10	1898.00
	Terra Beige	TM426 .11	1898.00
	Salt White	TM426 .12	2089.00
	Onyx White	TM426 .13	2089.00
6M Size Plate with 4 holes + 4M window  <p>For box size 8" x 3" (210mm x 75mm)</p>	Sparkle White	TM226 .10	1898.00
	Terra Beige	TM226 .11	1898.00
	Salt White	TM226 .12	2089.00
	Onyx White	TM226 .13	2089.00
6M Size Plate with 2 holes + 2Mx2 window  <p>For box size 8" x 3" (210mm x 75mm)</p>	Sparkle White	TM216 .10	1898.00
	Terra Beige	TM216 .11	1898.00
	Salt White	TM216 .12	2089.00
	Onyx White	TM216 .13	2089.00



Norisys TG9 Series plates set the standard for stylish design. They are available in top quality materials: Solid Aluminum, Solid Glass, Solid Wood, Solid Marble finish. The classy design creates an exclusive flair owing to the interaction of contrasts between the severity of optical forms and surface finish.

Each piece of Solid Marble Finish Plate is machined out of a solid block of composite to give it the sharp and clean look. These plates are available in Sparkle White, Terra Beige, Salt White and Onyx White colours that match very well with modules. The final composition after mounting looks well engineered and smart.

Solid Marble Finish Plates with frames

Various colour and pattern options

			Price Rs.
 <p>For box size 8" x 3" (210mm x 75mm)</p>	Sparkle White	TM326 .10	1898.00
	Terra Beige	TM326 .11	1898.00
	Salt White	TM326 .12	2089.00
	Onyx White	TM326 .13	2089.00
 <p>For box size 8" x 3" (210mm x 75mm)</p>	Sparkle White	TM306 .10	1530.00
	Terra Beige	TM306 .11	1530.00
	Salt White	TM306 .12	1685.00
	Onyx White	TM306 .13	1685.00
 <p>For box size 9"x3" or 8"x3" (230 / 210mm x 75mm)</p>	Sparkle White	TM818 .10	2073.00
	Terra Beige	TM818 .11	2073.00
	Salt White	TM818 .12	2282.00
	Onyx White	TM818 .13	2282.00
 <p>For box size 9"x3" or 8"x3" (230 / 210mm x 75mm)</p>	Sparkle White	TM828 .10	2073.00
	Terra Beige	TM828 .11	2073.00
	Salt White	TM828 .12	2282.00
	Onyx White	TM828 .13	2282.00
 <p>For box size 9"x3" or 8"x3" (230 / 210mm x 75mm)</p>	Sparkle White	TM618 .10	2073.00
	Terra Beige	TM618 .11	2073.00
	Salt White	TM618 .12	2282.00
	Onyx White	TM618 .13	2282.00
 <p>For box size 9"x3" or 8"x3" (230 / 210mm x 75mm)</p>	Sparkle White	TM418 .10	2073.00
	Terra Beige	TM418 .11	2073.00
	Salt White	TM418 .12	2282.00
	Onyx White	TM418 .13	2282.00
 <p>For box size 9"x3" or 8"x3" (230 / 210mm x 75mm)</p>	Sparkle White	TM428 .10	2073.00
	Terra Beige	TM428 .11	2073.00
	Salt White	TM428 .12	2282.00
	Onyx White	TM428 .13	2282.00
 <p>For box size 9"x3" or 8"x3" (230 / 210mm x 75mm)</p>	Sparkle White	TM228 .10	2073.00
	Terra Beige	TM228 .11	2073.00
	Salt White	TM228 .12	2282.00
	Onyx White	TM228 .13	2282.00



Solid Marble Finish Plates with frames

Various colour and pattern options

			Price Rs.
 <p>8M Size Plate with 5 holes + 3M window</p> <p>For box size 9"x3" or 8"x3" (230 / 210mm x 75mm)</p>	Sparkle White	TM518 .10	2073.00
	Terra Beige	TM518 .11	2073.00
	Salt White	TM518 .12	2282.00
	Onyx White	TM518 .13	2282.00
	<hr/>		
 <p>8M Size Plate with 10 holes + 3M window</p> <p>For box size 9"x3" or 8"x3" (230 / 210mm x 75mm)</p>	Sparkle White	TM528 .10	2073.00
	Terra Beige	TM528 .11	2073.00
	Salt White	TM528 .12	2282.00
	Onyx White	TM528 .13	2282.00
	<hr/>		
 <p>8M Size Plate with 12 holes + 2M window</p> <p>For box size 9"x3" or 8"x3" (230 / 210mm x 75mm)</p>	Sparkle White	TM628 .10	2073.00
	Terra Beige	TM628 .11	2073.00
	Salt White	TM628 .12	2282.00
	Onyx White	TM628 .13	2282.00
	<hr/>		
 <p>8M Size Plate with 8M window</p> <p>For box size 9"x3" or 8"x3" (230 / 210mm x 75mm)</p>	Sparkle White	TM308 .10	1658.00
	Terra Beige	TM308 .11	1658.00
	Salt White	TM308 .12	1825.00
	Onyx White	TM308 .13	1825.00
	<hr/>		

TG9 Series

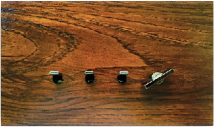

Solid Wood Plates with frames

Dark Mahogany, Pinewood and Walnut

Price Rs.

1M Size Plate with 1 hole



Suitable for box size 3" x 3"
(75mm x 75mm)

Dark Mahogany	TW111 .06	1556.00
Pinewood	TW111 .07	1556.00
Walnut	TW111 .29	1634.00

1M Size Plate with 1M window



Suitable for box size 3" x 3"
(75mm x 75mm)

Dark Mahogany	TW301 .06	1256.00
Pinewood	TW301 .07	1256.00
Walnut	TW301 .29	1319.00

2M Size Plate with 2 holes



Suitable for box size 3" x 3"
(75mm x 75mm)

Dark Mahogany	TW212 .06	1556.00
Pinewood	TW212 .07	1556.00
Walnut	TW212 .29	1634.00

2M Size Plate with 4 holes



Suitable for box size 3" x 3"
(75mm x 75mm)

Dark Mahogany	TW222 .06	1556.00
Pinewood	TW222 .07	1556.00
Walnut	TW222 .29	1634.00

2M Size Plate with 2 holes + 1M window



Suitable for box size 3" x 3"
(75mm x 75mm)

Dark Mahogany	TW122 .06	1556.00
Pinewood	TW122 .07	1556.00
Walnut	TW122 .29	1634.00

2M Size Plate with 1 holes + 1M window



Suitable for box size 3" x 3"
(75mm x 75mm)

Dark Mahogany	TW112 .06	1556.00
Pinewood	TW112 .07	1556.00
Walnut	TW112 .29	1634.00

2M Size Plate with 2M window



Suitable for box size 3" x 3"
(75mm x 75mm)

Dark Mahogany	TW302 .06	1275.00
Pinewood	TW302 .07	1275.00
Walnut	TW302 .29	1339.00

3M Size Plate with 3 holes



Suitable for box size 4" x 3"
(100mm x 75mm)

Dark Mahogany	TW313 .06	1649.00
Pinewood	TW313 .07	1649.00
Walnut	TW313 .29	1732.00

3M Size Plate with 6 holes



Suitable for box size 4" x 3"
(100mm x 75mm)

Dark Mahogany	TW323 .06	1649.00
Pinewood	TW323 .07	1649.00
Walnut	TW323 .29	1732.00



Solid Wood Plates with frames

Dark Mahogany, Pinewood and Walnut

Price Rs.

3M Size Plate with 2 holes + 2M window



Suitable for box size 4" x 3"
(100mm x 75mm)

Dark Mahogany	TW123 .06	1649.00
Pinewood	TW123 .07	1649.00
Walnut	TW123 .29	1732.00

3M Size Plate with 1 hole + 2M window



Suitable for box size 4" x 3"
(100mm x 75mm)

Dark Mahogany	TW113 .06	1649.00
Pinewood	TW113 .07	1649.00
Walnut	TW113 .29	1732.00

3M Size Plate with 3M window



Suitable for box size 4" x 3"
(100mm x 75mm)

Dark Mahogany	TW303 .06	1352.00
Pinewood	TW303 .07	1352.00
Walnut	TW303 .29	1420.00

4M Size Plate with 4 holes



For box size 5" x 3"
(135mm x 75mm)

Dark Mahogany	TW414 .06	1869.00
Pinewood	TW414 .07	1869.00
Walnut	TW414 .29	1962.00

4M Size Plate with 8 holes



For box size 5" x 3"
(135mm x 75mm)

Dark Mahogany	TW424 .06	1869.00
Pinewood	TW424 .07	1869.00
Walnut	TW424 .29	1962.00

4M Size Plate with 2 holes + 2M window



For box size 5" x 3"
(135mm x 75mm)

Dark Mahogany	TW214 .06	1869.00
Pinewood	TW214 .07	1869.00
Walnut	TW214 .29	1962.00

4M Size Plate with 4 holes + 2M window



For box size 5" x 3"
(135mm x 75mm)

Dark Mahogany	TW224 .06	1869.00
Pinewood	TW224 .07	1869.00
Walnut	TW224 .29	1962.00

4M Size Plate with 2 holes + 3M window



For box size 5" x 3"
(135mm x 75mm)

Dark Mahogany	TW124 .06	1869.00
Pinewood	TW124 .07	1869.00
Walnut	TW124 .29	1962.00

4M Size Plate with 4M window



For box size 5" x 3"
(135mm x 75mm)

Dark Mahogany	TW304 .06	1520.00
Pinewood	TW304 .07	1520.00
Walnut	TW304 .29	1595.00



Solid Wood Plates with frames

Dark Mahogany, Pinewood and Walnut

Price Rs.

6M Size Plate with 6 holes



For box size 8" x 3"
(210mm x 75mm)

Dark Mahogany	TW616 .06	2064.00
Pinewood	TW616 .07	2064.00
Walnut	TW616 .29	2166.00

6M Size Plate with 12 holes



For box size 8" x 3"
(210mm x 75mm)

Dark Mahogany	TW626 .06	2064.00
Pinewood	TW626 .07	2064.00
Walnut	TW626 .29	2166.00

6M Size Plate with 4 holes + 2M window



For box size 8" x 3"
(210mm x 75mm)

Dark Mahogany	TW416 .06	2064.00
Pinewood	TW416 .07	2064.00
Walnut	TW416 .29	2166.00

6M Size Plate with 8 holes + 2M window



For box size 8" x 3"
(210mm x 75mm)

Dark Mahogany	TW426 .06	2064.00
Pinewood	TW426 .07	2064.00
Walnut	TW426 .29	2166.00

6M Size Plate with 4 holes + 4M window



For box size 8" x 3"
(210mm x 75mm)

Dark Mahogany	TW226 .06	2064.00
Pinewood	TW226 .07	2064.00
Walnut	TW226 .29	2166.00

6M Size Plate with 2 holes + 2Mx2 window



For box size 8" x 3"
(210mm x 75mm)

Dark Mahogany	TW216 .06	2064.00
Pinewood	TW216 .07	2064.00
Walnut	TW216 .29	2166.00

6M Size Plate with 6 holes + 3M window



For box size 8" x 3"
(210mm x 75mm)

Dark Mahogany	TW326 .06	2064.00
Pinewood	TW326 .07	2064.00
Walnut	TW326 .29	2166.00

6M Size Plate with 6M window



For box size 8" x 3"
(210mm x 75mm)

Dark Mahogany	TW306 .06	1664.00
Pinewood	TW306 .07	1664.00
Walnut	TW306 .29	1747.00

8M Size Plate with 8 hole



For box size 9"x3" or 8"x3"
(230 / 210mm x 75mm)

Dark Mahogany	TW818 .06	2252.00
Pinewood	TW818 .07	2252.00
Walnut	TW818 .29	2364.00



Solid Wood Plates with frames

Dark Mahogany, Pinewood and Walnut

Price Rs.

8M Size Plate with 16 holes



For box size 9"x3" or 8"x3"
(230 / 210mm x 75mm)

Dark Mahogany	TW828 .06	2252.00
Pinewood	TW828 .07	2252.00
Walnut	TW828 .29	2364.00

8M Size Plate with 6 holes + 2M window



For box size 9"x3" or 8"x3"
(230 / 210mm x 75mm)

Dark Mahogany	TW618 .06	2252.00
Pinewood	TW618 .07	2252.00
Walnut	TW618 .29	2364.00

8M Size Plate with 4 holes + 4M window



For box size 9"x3" or 8"x3"
(230 / 210mm x 75mm)

Dark Mahogany	TW418 .06	2252.00
Pinewood	TW418 .07	2252.00
Walnut	TW418 .29	2364.00

8M Size Plate with 8 holes + 4M window



For box size 9"x3" or 8"x3"
(230 / 210mm x 75mm)

Dark Mahogany	TW428 .06	2252.00
Pinewood	TW428 .07	2252.00
Walnut	TW428 .29	2364.00

8M Size Plate with 4 holes + 6M window



For box size 9"x3" or 8"x3"
(230 / 210mm x 75mm)

Dark Mahogany	TW228 .06	2252.00
Pinewood	TW228 .07	2252.00
Walnut	TW228 .29	2364.00

8M Size Plate with 5 holes + 3M window



For box size 9"x3" or 8"x3"
(230 / 210mm x 75mm)

Dark Mahogany	TW518 .06	2252.00
Pinewood	TW518 .07	2252.00
Walnut	TW518 .29	2364.00

8M Size Plate with 10 holes + 3M window



For box size 9"x3" or 8"x3"
(230 / 210mm x 75mm)

Dark Mahogany	TW528 .06	2252.00
Pinewood	TW528 .07	2252.00
Walnut	TW528 .29	2364.00

8M Size Plate with 12 holes + 2M window



For box size 9"x3" or 8"x3"
(230 / 210mm x 75mm)

Dark Mahogany	TW628 .06	2252.00
Pinewood	TW628 .07	2252.00
Walnut	TW628 .29	2364.00

8M Size Plate with 8M window



For box size 9"x3" or 8"x3"
(230 / 210mm x 75mm)

Dark Mahogany	TW308 .06	1801.00
Pinewood	TW308 .07	1801.00
Walnut	TW308 .29	1891.00

Engineering Plastics

Materials chosen for superior finish and endurance



Charcoal Black

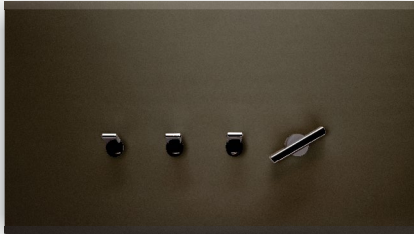

Quartz Gray

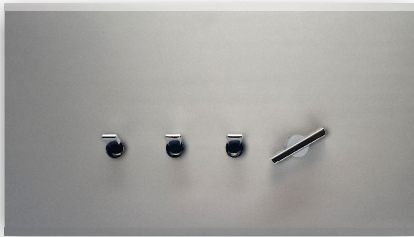

Silver Dust

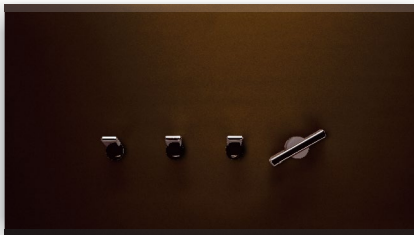

Cocoa Brown

These plates are made of engineering plastics. They are an example of our longevity approach, where we endeavor to extend the lifetime of the product substantially beyond industry standards.

The plates are designed with a modular

approach, making it easy to maintain and service. For example, customers can replace the switches or sockets and customize the combinations with new materials and / or colours as per their own

TG9

5936.53.1



Flats'5 Plates with frames

Various colour options

			Price Rs.
 <p>1M Size Plate with 1 hole</p> <p>Suitable for box size 3" x 3" (75mm x 75mm)</p>	Quartz Gray	TP111 .02	660.00
	Charcoal Black	TP111 .17	825.00
	Cocoa Brown	TP111 .25	825.00
	Silver Dust	TP111 .26	825.00
 <p>1M Size Plate with 1M window</p> <p>Suitable for box size 3" x 3" (75mm x 75mm)</p>	Quartz Gray	TP301 .02	401.00
	Charcoal Black	TP301 .17	498.00
	Cocoa Brown	TP301 .25	498.00
	Silver Dust	TP301 .26	498.00
 <p>2M Size Plate with 2 holes</p> <p>Suitable for box size 3" x 3" (75mm x 75mm)</p>	Quartz Gray	TP212 .02	660.00
	Charcoal Black	TP212 .17	825.00
	Cocoa Brown	TP212 .25	825.00
	Silver Dust	TP212 .26	825.00
 <p>2M Size Plate with 4 holes</p> <p>Suitable for box size 3" x 3" (75mm x 75mm)</p>	Quartz Gray	TP222 .02	660.00
	Charcoal Black	TP222 .17	825.00
	Cocoa Brown	TP222 .25	825.00
	Silver Dust	TP222 .26	825.00
 <p>2M Size Plate with 2 holes + 1M window</p> <p>Suitable for box size 3" x 3" (75mm x 75mm)</p>	Quartz Gray	TP122 .02	660.00
	Charcoal Black	TP122 .17	825.00
	Cocoa Brown	TP122 .25	825.00
	Silver Dust	TP122 .26	825.00
 <p>2M Size Plate with 1 holes + 1M window</p> <p>Suitable for box size 3" x 3" (75mm x 75mm)</p>	Quartz Gray	TP112 .02	660.00
	Charcoal Black	TP112 .17	825.00
	Cocoa Brown	TP112 .25	825.00
	Silver Dust	TP112 .26	825.00
 <p>2M Size Plate with 2M window</p> <p>Suitable for box size 3" x 3" (75mm x 75mm)</p>	Quartz Gray	TP302 .02	436.00
	Charcoal Black	TP302 .17	573.00
	Cocoa Brown	TP302 .25	573.00
	Silver Dust	TP302 .26	573.00
 <p>3M Size Plate with 3 holes</p> <p>Suitable for box size 4" x 3" (100mm x 75mm)</p>	Quartz Gray	TP313 .02	730.00
	Charcoal Black	TP313 .17	913.00
	Cocoa Brown	TP313 .25	913.00
	Silver Dust	TP313 .26	913.00

TG9 Series



Flats'5 Plates with frames

Various colour options

			Price Rs.
 <p>Suitable for box size 4" x 3" (100mm x 75mm)</p>	Quartz Gray	TP323 .02	730.00
	Charcoal Black	TP323 .17	913.00
	Cocoa Brown	TP323 .25	913.00
	Silver Dust	TP323 .26	913.00
	<hr/>		
 <p>Suitable for box size 4" x 3" (100mm x 75mm)</p>	Quartz Gray	TP123 .02	730.00
	Charcoal Black	TP123 .17	913.00
	Cocoa Brown	TP123 .25	913.00
	Silver Dust	TP123 .26	913.00
<hr/>			
 <p>Suitable for box size 4" x 3" (100mm x 75mm)</p>	Quartz Gray	TP113 .02	730.00
	Charcoal Black	TP113 .17	913.00
	Cocoa Brown	TP113 .25	913.00
	Silver Dust	TP113 .26	913.00
<hr/>			
 <p>Suitable for box size 4" x 3" (100mm x 75mm)</p>	Quartz Gray	TP303 .02	482.00
	Charcoal Black	TP303 .17	625.00
	Cocoa Brown	TP303 .25	625.00
	Silver Dust	TP303 .26	625.00
<hr/>			
 <p>For box size 5" x 3" (135mm x 75mm)</p>	Quartz Gray	TP414 .02	776.00
	Charcoal Black	TP414 .17	970.00
	Cocoa Brown	TP414 .25	970.00
	Silver Dust	TP414 .26	970.00
<hr/>			
 <p>For box size 5" x 3" (135mm x 75mm)</p>	Quartz Gray	TP424 .02	776.00
	Charcoal Black	TP424 .17	970.00
	Cocoa Brown	TP424 .25	970.00
	Silver Dust	TP424 .26	970.00
<hr/>			
 <p>For box size 5" x 3" (135mm x 75mm)</p>	Quartz Gray	TP214 .02	776.00
	Charcoal Black	TP214 .17	970.00
	Cocoa Brown	TP214 .25	970.00
	Silver Dust	TP214 .26	970.00
<hr/>			
 <p>For box size 5" x 3" (135mm x 75mm)</p>	Quartz Gray	TP224 .02	776.00
	Charcoal Black	TP224 .17	970.00
	Cocoa Brown	TP224 .25	970.00
	Silver Dust	TP224 .26	970.00
<hr/>			

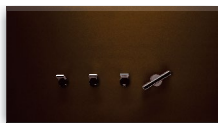

Flats'5 Plates with frames









Various colour options

			Price Rs.
 <p>4M Size Plate with 2 holes + 3M window For box size 5" x 3" (135mm x 75mm)</p>	Quartz Gray	TP124 .02	776.00
	Charcoal Black	TP124 .17	970.00
	Cocoa Brown	TP124 .25	970.00
	Silver Dust	TP124 .26	970.00
	<hr/>		
 <p>4M Size Plate with 4M window For box size 5" x 3" (135mm x 75mm)</p>	Quartz Gray	TP304 .02	512.00
	Charcoal Black	TP304 .17	671.00
	Cocoa Brown	TP304 .25	671.00
	Silver Dust	TP304 .26	671.00
<hr/>			
 <p>6M Size Plate with 6 holes For box size 8" x 3" (210mm x 75mm)</p>	Quartz Gray	TP616 .02	1402.00
	Charcoal Black	TP616 .17	1753.00
	Cocoa Brown	TP616 .25	1753.00
	Silver Dust	TP616 .26	1753.00
<hr/>			
 <p>6M Size Plate with 12 holes For box size 8" x 3" (210mm x 75mm)</p>	Quartz Gray	TP626 .02	1402.00
	Charcoal Black	TP626 .17	1753.00
	Cocoa Brown	TP626 .25	1753.00
	Silver Dust	TP626 .26	1753.00
<hr/>			
 <p>6M Size Plate with 4 holes + 2M window For box size 8" x 3" (210mm x 75mm)</p>	Quartz Gray	TP416 .02	1402.00
	Charcoal Black	TP416 .17	1753.00
	Cocoa Brown	TP416 .25	1753.00
	Silver Dust	TP416 .26	1753.00
<hr/>			
 <p>6M Size Plate with 8 holes + 2M window For box size 8" x 3" (210mm x 75mm)</p>	Quartz Gray	TP426 .02	1402.00
	Charcoal Black	TP426 .17	1753.00
	Cocoa Brown	TP426 .25	1753.00
	Silver Dust	TP426 .26	1753.00
<hr/>			
 <p>6M Size Plate with 4 holes + 4M window For box size 8" x 3" (210mm x 75mm)</p>	Quartz Gray	TP226 .02	1402.00
	Charcoal Black	TP226 .17	1753.00
	Cocoa Brown	TP226 .25	1753.00
	Silver Dust	TP226 .26	1753.00
<hr/>			
 <p>6M Size Plate with 2 holes + 2Mx2 window For box size 8" x 3" (210mm x 75mm)</p>	Quartz Gray	TP216 .02	1402.00
	Charcoal Black	TP216 .17	1753.00
	Cocoa Brown	TP216 .25	1753.00
	Silver Dust	TP216 .26	1753.00
<hr/>			



Flats'5 Plates with frames

Various colour options

			Price Rs.
 <p>6M Size Plate with 6 holes + 3M window</p> <p>For box size 8" x 3" (210mm x 75mm)</p>	Quartz Gray	TP326 .02	1402.00
	Charcoal Black	TP326 .17	1753.00
	Cocoa Brown	TP326 .25	1753.00
	Silver Dust	TP326 .26	1753.00
 <p>6M Size Plate with 6M window</p> <p>For box size 8" x 3" (210mm x 75mm)</p>	Quartz Gray	TP306 .02	926.00
	Charcoal Black	TP306 .17	1154.00
	Cocoa Brown	TP306 .25	1154.00
	Silver Dust	TP306 .26	1154.00
 <p>8M Size Plate with 8 hole</p> <p>For box size 9"x3" or 8"x3" (230 / 210mm x 75mm)</p>	Quartz Gray	TP818 .02	1555.00
	Charcoal Black	TP818 .17	1944.00
	Cocoa Brown	TP818 .25	1944.00
	Silver Dust	TP818 .26	1944.00
 <p>8M Size Plate with 16 hole</p> <p>For box size 9"x3" or 8"x3" (230 / 210mm x 75mm)</p>	Quartz Gray	TP828 .02	1555.00
	Charcoal Black	TP828 .17	1944.00
	Cocoa Brown	TP828 .25	1944.00
	Silver Dust	TP828 .26	1944.00
 <p>8M Size Plate with 6 holes + 2M window</p> <p>For box size 9"x3" or 8"x3" (230 / 210mm x 75mm)</p>	Quartz Gray	TP618 .02	1555.00
	Charcoal Black	TP618 .17	1944.00
	Cocoa Brown	TP618 .25	1944.00
	Silver Dust	TP618 .26	1944.00
 <p>8M Size Plate with 4 holes + 4M window</p> <p>For box size 9"x3" or 8"x3" (230 / 210mm x 75mm)</p>	Quartz Gray	TP418 .02	1555.00
	Charcoal Black	TP418 .17	1944.00
	Cocoa Brown	TP418 .25	1944.00
	Silver Dust	TP418 .26	1944.00
 <p>8M Size Plate with 8 holes + 4M window</p> <p>For box size 9"x3" or 8"x3" (230 / 210mm x 75mm)</p>	Quartz Gray	TP428 .02	1555.00
	Charcoal Black	TP428 .17	1944.00
	Cocoa Brown	TP428 .25	1944.00
	Silver Dust	TP428 .26	1944.00
 <p>8M Size Plate with 4 holes + 6M window</p> <p>For box size 9"x3" or 8"x3" (230 / 210mm x 75mm)</p>	Quartz Gray	TP228 .02	1555.00
	Charcoal Black	TP228 .17	1944.00
	Cocoa Brown	TP228 .25	1944.00
	Silver Dust	TP228 .26	1944.00



Flats'5 Plates with frames

Various colour options

			Price Rs.
 <p>8M Size Plate with 5 holes + 3M window</p> <p>For box size 9"x3" or 8"x3" (230 / 210mm x 75mm)</p>	Quartz Gray	TP518 .02	1555.00
	Charcoal Black	TP518 .17	1944.00
	Cocoa Brown	TP518 .25	1944.00
	Silver Dust	TP518 .26	1944.00
	<hr/>		
 <p>8M Size Plate with 10 holes + 3M window</p> <p>For box size 9"x3" or 8"x3" (230 / 210mm x 75mm)</p>	Quartz Gray	TP528 .02	1555.00
	Charcoal Black	TP528 .17	1944.00
	Cocoa Brown	TP528 .25	1944.00
	Silver Dust	TP528 .26	1944.00
	<hr/>		
 <p>8M Size Plate with 12 holes + 2M window</p> <p>For box size 9"x3" or 8"x3" (230 / 210mm x 75mm)</p>	Quartz Gray	TP628 .02	1555.00
	Charcoal Black	TP628 .17	1944.00
	Cocoa Brown	TP628 .25	1944.00
	Silver Dust	TP628 .26	1944.00
	<hr/>		
 <p>8M Size Plate with 8M window</p> <p>For box size 9"x3" or 8"x3" (230 / 210mm x 75mm)</p>	Quartz Gray	TP308 .02	1027.00
	Charcoal Black	TP308 .17	1252.00
	Cocoa Brown	TP308 .25	1252.00
	Silver Dust	TP308 .26	1252.00
	<hr/>		



Electrical safety advantage
 Unique ring-shaped springs in sockets









Norisys engineers developed a unique ring-shaped spring which solves the frequently occurring problem of burnouts in power sockets. Norisys sockets feature this ring-shaped spring which maintains a uniform pressure on the brass contact tubes. This pressure clamps the plug pins tightly leading to a spark-free

contact, thus eliminating overheating and consequential burnouts. Norisys sockets are designed for extreme endurance. Materials are chosen to withstand arduous conditions. Local wiring practices are carefully studied before designing any new product.

Sockets

Quartz Gray

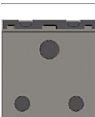
				Price Rs.
	Socket 6A 2 Pin [Round & Flat] 1 Module *	Quartz Gray	T5010 .02	268.00
	Socket 6A 3+2 Pin [Round & Flat] Shuttered - 2 Module *	Quartz Gray	T5212 .02	399.00
	Socket 6A 3 Pin-only Shuttered 2 Module (As per Indian Standard)	Quartz Gray	T5213 .02	374.00
	Socket 13A International Multi Socket Shuttered - 2 Module *	Quartz Gray	T5532 .02	481.00
	Socket 13A 3-Pin Flat only Socket Shuttered - 2 Module *	Quartz Gray	T5531 .02	457.00
	Socket 16A and 6A 3-Pin Shuttered 2 Module (As per Indian Standard)	Quartz Gray	T5332 .02	481.00
	Socket 16A 3-Pin-only Shuttered 2 Module (As per Indian Standard)	Quartz Gray	T5331 .02	467.00

* Only for export outside India

Thermoset material advantage

Use of material that does not melt on heating







Use of engineering grade thermoset material in TG9 Series products makes the range extremely strong and sturdy with flame proof qualities. The engineering grade thermoset material used in the products has excellent electrical insulation

properties and does not melt upon heating. This ensures that the products are capable of handling higher operating temperatures. This engineering grade thermoset material is conventionally used in industrial applications where a high

Sockets

Quartz Gray







				Price Rs.
	Socket 25A and 6A 3-Pin Shuttered 2 Module *	Quartz Gray	T5732 .02	559.00
	Socket 25A 3-Pin-only Shuttered 2 Module *	Quartz Gray	T5733 .02	539.00
	Socket 16A and 6A 3-Pin Shuttered 3 Module (As per Indian Standard)	Quartz Gray	T5552 .02	552.00
	Socket 25A and 6A 3-Pin Shuttered 3 Module *	Quartz Gray	T5752 .02	659.00

* Only for export outside India



Fan Regulators & Dimmers

Metal and plastic options

			Price Rs.
	Fan Regulator for 80W fan - Step Type with Bar Knob - 1 Module	Metal Chrome Glossy	T9900 .31 1964.00
		Metal Chrome Matt	T9900 .32 2017.00
		Metal Black Glossy	T9900 .33 2071.00
		Metal Mellow Gold	T9900 .34 2132.00
		Plastic Quartz Gray	T9900 .02 1670.00
	Fan Regulator for 80W fan - Step Type with Bar Knob + Blank - 1 Module	Metal Chrome Glossy	T9907 .31 2105.00
		Metal Chrome Matt	T9907 .32 2161.00
		Metal Black Glossy	T9907 .33 2217.00
		Metal Mellow Gold	T9907 .34 2280.00
		Plastic Quartz Gray	T9907 .02 1808.00
	Dimmer 500 Watts 1 Module	Plastic Quartz Gray	T9905 .02 1034.00
	Dimmer 500 Watts + Blank 1 Module	Plastic Quartz Gray	T9912 .02 1173.00
	Dimmer for LED Light 100W (3 wire system) 1 Module	Plastic Quartz Gray	T9908 .02 1027.00
	Dimmer for LED Light 100W (3 wire system) + Blank - 1 Module	Plastic Quartz Gray	T9913 .02 1166.00







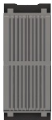

Products like Speakers for Audio Music, Night Lights with Dimming Option, Step Marker Lamps, Prismatic Overdoor Bulkhead Indicators etc. when mounted with modular switches provide the necessary convenience in modern buildings apart from adding to the style quotient. These installations not only look

good, but are also ideally convenient to operate. These products are all mounted on bi-material support frames in TG9 Series. The bi-material frames are made of a combination of steel and engineering grade plastic. In this design, a steel structure is embedded into the plastic to

Acoustic & Optical Signaling

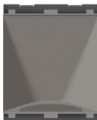
Quartz Gray



			Price Rs.
	Indicator Light 1 Module	Quartz Gray	T5727 .02 359.00
	Electronic Buzzer 1 Module	Quartz Gray	T5710 .02 634.00
	Electronic Buzzer 2 Module	Quartz Gray	T5709 .02 718.00
	Prismatic Overdoor Bulkhead Indicator Red - 2 Module	Quartz Gray	T5705 .02 599.00
	Emergency Light 2 Module	Quartz Gray	T5715 .02 1926.00
	Step Marker Lamp/ Night Lamp 2 Module	Quartz Gray	T5721 .02 806.00
	Electronic Bell 2 Module	Quartz Gray	T5707 .02 794.00



Norisy's has a full fledged, well equipped research and development division which works constantly to improve, innovate and engineer new products. This research and development division has a fully integrated product development environment that directs the development process throughout, right from concept design to manufacturing.

Acoustic & Optical Signaling

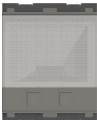
Quartz Gray

			Price Rs.
	Speaker for audio music circuit 2 Module	Quartz Gray	T5706 .02 1399.00
<hr/>			
	Night Light with switch and dimming option - 2 Module	Quartz Gray	T5716 .02 1222.00
<hr/>			
	Ultrasonic Mosquito Repellent 2 Module	Quartz Gray	T5708 .02 1135.00









TG9 Series installations do not only look good, they are also extremely convenient to operate. This quality is especially required in hotels and hospitals where one seeks quiet and wellbeing. In such environments, it is important to have fittings that stand for good feeling. Products like Shaver Sockets, Key Card Switches, Call bell systems with register, Buzzers, Speakers for Music circuits, Step Marker Night

Lights, Do Not Disturb and Clean My Room dedicated switches, Bell Switch with DND & Clean My Room connections provide the necessary convenience for guests in hotels. Plates merge with the building interiors very well, thereby creating a homogeneous look. Inner bi-material frames give adequate support to the plates, thereby keeping all the modules securely

Hospitality Modules

Quartz Gray







			Price Rs.	
	"Do Not Disturb" Switch with indicator 1 Module	Quartz Gray	T5232 .02	515.00
	Key Fob - Customized	Quartz Gray	T5720 .02	241.00
	25A Key Fob Switch Double Pole with indicator - 2 Module	Quartz Gray	T5719 .02	1624.00
	Call Bell Station with Register and Provision for External Buzzer 2 Module	Quartz Gray	T5711 .02	1639.00
	External Buzzer for call bell Station 2 Module	Quartz Gray	T5712 .02	651.00
	Push Button station (Start - Stop) 2 Module	Quartz Gray	T5450 .02	720.00
	Curtain Control Switch 6A 2 Module	Quartz Gray	T5460 .02	799.00



Architecture of modern hotels and hospitals makes the highest demand for design and function of electrical installations. Norisys offers high-end products suited for the hospitality industry. Good quality card operated switches are a prerequisite in all hotels these days for energy saving. With this in mind, Norisys offers a

Hospitality Modules

Quartz Gray

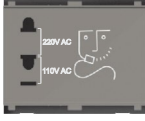
			Price Rs.	
	"Clean My Room" Switch with Indicator 1 Module	Quartz Gray	T5233 .02	515.00
	Volume Control 100 Ohms 1 Watt 2 Module	Quartz Gray	T5906 .02	893.00
	Bell Switch with "Do Not Disturb" & "Clean My Room" Indicator 2 Module	Quartz Gray	T5262 .02	877.00
	Bell Switch with "DND", "CMR" & Guest is in Indicator - 2 Module	Quartz Gray	T5263 .02	946.00
	25A Smart Card operated Electronic switch in 2 Module with indicator & exit time delay feature including Smart Card - 2 Module	Quartz Gray	T5717 .02	3270.00
	25A Smart Card operated Electronic switch in 3 Module with indicator & exit time delay feature including Smart Card - 3 Module	Quartz Gray	T5718 .02	3036.00
	Shaver Socket 220V/110V 3 Module	Quartz Gray	T5723 .02	2885.00









Communicate and Support Modules from Norisy's have been developed to establish new standards in electrical accessories. Commitment to superior designs, elaborate attention to engineering details, modern manufacturing facilities and stringent quality measures have combined together to create a new concept in safety, reliability, flexibility and

Norisy's has a full fledged, well equipped research and development division which works constantly to improve, innovate and engineer new products. This research and development division has a fully integrated product development environment that directs the development process throughout,

Communique & Support Modules







Quartz Gray

				Price Rs.
	Coaxil T.V Socket 1 Module	Quartz Gray	T5797 .02	277.00
	USB Extension Socket 1 Module	Quartz Gray	T5725 .02	656.00
	USB Charger Socket Outlet A Type - 2.1 Amps 1 Module	Quartz Gray	T5736 .02	2998.00
	USB Charger Socket Outlet C Type - 2.1 Amps 1 Module	Quartz Gray	T5836 .02	3316.00
	USB Charger Socket Outlet A+C Type - 2.1 Amps - 1 Module	Quartz Gray	T5936 .02	3583.00
	USB Charger Socket Outlet C+C Type - 3.1 Amps - 1 Module	Quartz Gray	T5937 .02	4108.00
	Telephone Socket RJ-11 Double Line Shuttered 1 Module	Quartz Gray	T5800 .02	266.00



Communique & Support Modules

Quartz Gray

			Price Rs.
	Twin Telephone Socket RJ-11 1 Module	Quartz Gray	T5820 .02 427.00
	Information Socket 6e - UTP Shuttered 1 Module	Quartz Gray	T5802 .02 976.00
	Information Socket 6a - UTP Shuttered 1 Module	Quartz Gray	T5803 .02 1648.00
	Triple RCA Audio Visual Socket 1 Module	Quartz Gray	T5701 .02 903.00
	Cord Outlet 1 Module	Quartz Gray	T5500 .02 200.00
	Blanking Plate 1 Module	Quartz Gray	T5700 .02 71.00
	Audio Port / Jack 3.5mm 1 Module	Quartz Gray	T5798 .02 523.00





TG9 Series marks the evolution of Norisys' research as it once again focuses on engineering design, especially its environmental qualities & pivots on the concept of variability and sustainability, performance and simplicity of use. It is a new way of creating environments, made possible by the types of products that have been developed, namely by using advanced materials and engineering. The result is an installation system that blends seamlessly with the building.

A professional of electrical switchgear, Norisys today constructs innovative switchgear systems at the highest level and has established and by many years of experience and high quality workmanship, TG9 Series is the best example of the same.

Communique & Support Modules

Quartz Gray

			Price Rs.	
	Fitment for RJ-45 Computer Socket Shuttered 1 Module	Quartz Gray	T5809 .02	295.00
	Computer Monitor Output Socket 1 Module	Quartz Gray	T5729 .02	457.00
	HDMI Socket 1 Module	Quartz Gray	T5739 .02	1787.00

TG9 Series exploded view

Solid, heavy products with fine precision engineering resulting in trouble-free operation.

Cover plate can be snap fit onto the frames after final painting of walls.

Strong and precise locks for sturdy mounting and easy removal.

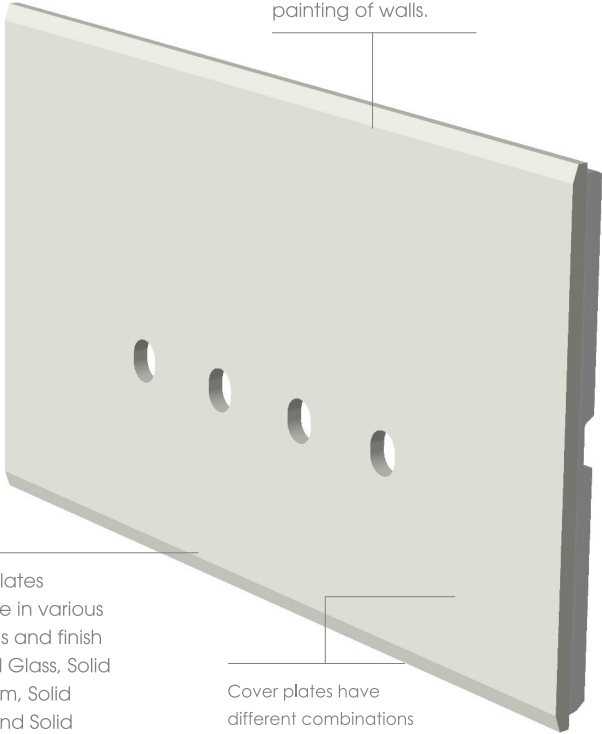

Cover plates available in various materials and finish like Solid Glass, Solid Aluminum, Solid Wood and Solid Marble Finish.

Cover plates have different combinations of holes and windows. Holes are meant for switches and fan regulators, while the windows are meant for all other modules.

TG9 Series switches are available in Metal Chrome Glossy, Metal Chrome Matt, Metal Black Glossy, Metal Mellow Gold and Plastic Quartz Gray versions.

Thermoset material which can be seen in red colour is used inside to house the live metal parts. This material is extremely high heat resistant and does not melt on heating.

Engineering grade polycarbonate with high impact resistance and ultraviolet light resistance .

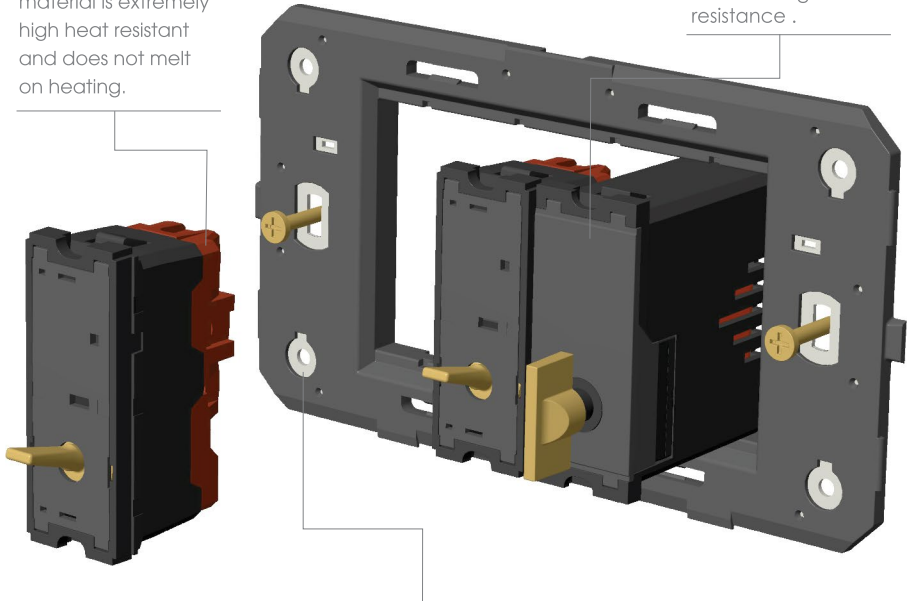

Bi-material frames that have high quality steel embedded inside thermoplastic. A result of advanced engineering, this combination leads to extra stiffness and tight tolerances for mounting of modules.

Prices, if any, quoted in this document supersede all previous prices. For technical information, please logon to www.norisys.com.

Detailed information on TG9 Series, Cube Series and Square Series products can be found on the website.

Die in diesem Dokument gegebenenfalls angegebenen Preise ersetzen alle früheren Preise. Bitte logge dich für technische Informationen auf www.norisys.com ein.

Detaillierte Informationen zu den Produkten der TG9-Serie, der Cube-Serie und der Square-Serie findest du auf dieser Website.

norisys[®]



@All rights reserved. Norisys is a registered trademark.

Wiring of electrical products should be done by trained professionals following all safety norms.

@Alle Rechte vorbehalten. Norisys ist eine eingetragene Marke.

Elektroinstallationen dürfen nur von entsprechend ausgebildeten Fachkräften unter Beachtung der maßgeblichen Sicherheitsrichtlinien vorgenommen werden.

Headquarters

Norisys Technology Private Limited
14/3 Mathura Road
Faridabad - 121 003, India

CIN: U31101DL1987PTC026630

Toll free: 1 800 11 1617

Tel: +91 11 49126360, 42657036

WhatsApp: +91 8800397858

Email: sales@norisys.com

Web: www.norisys.com